

•••
B

E. R. BUTLER & CO.

The W.C. Vaughan Co. Collection

MANUFACTURERS

BOSTON · NEW YORK

EST. 1990

2019

E. R. BUTLER & CO.

W. C. VAUGHAN CO.
COLLECTION

Description

E. R. BUTLER & CO. is pleased to offer the W.C. Vaughan Company's complete line of Early American and Georgian period hardware. For over a century, the W.C. Vaughan Company manufactured high quality architectural, builders' and furniture hardware from its unique design archive, a collection of early nineteenth-century hardware patterns and drawings from houses throughout New England and the Atlantic seaboard.

Renowned for its expertise, the W.C. Vaughan Company always relied upon the most precise tooling and best manufacturing methods available, supplying hardware for such restoration projects as Colonial Williamsburg. As W.C. Vaughan's successor, E.R. Butler & Co. continues to produce hardware of superior design, workmanship and finish so that the reproduction conveys the distinct qualities of the original.

Early American and Georgian period door knobs range in size from 3 inch diameter knobs to 1 3/4 inch diameter screen door knobs. Cabinet and fine furniture knobs range in size from 1 1/2 inch diameter cabinet knobs to 1/2 inch diameter drawer knobs. Available in many decorative finishes, all design series are fully complimented by architectural trim including hinges, finials, latches, locks, French window and cane bolts, surface bolts, quadrants, cylinder rings and covers, key escutcheons and covers, thumb turns, doorstops, etc.

E.R. BUTLER & CO.

ENTRY DOOR PULLS & LATCHES

© E.R. BUTLER & CO. ALL RIGHTS RESERVED.

FINE ARCHITECTURAL, BUILDERS' AND CABINETMAKERS' HARDWARE

E. R. BUTLER & CO.



PREMIUM GRADE

“Hamilton” Series Center Knob and Plate
W.C. Vaughan Company Collection

For Entry Doors.
4½ in. Diameter Center Knob with 8¾ in. Diameter Plate.
Solid Turned Brass Knob and Plate.
Standard, Custom Plated and Patinated Finishes Available.

½ Scale

FINE ARCHITECTURAL, BUILDERS' AND CABINETMAKERS' HARDWARE

E. R. BUTLER & CO.

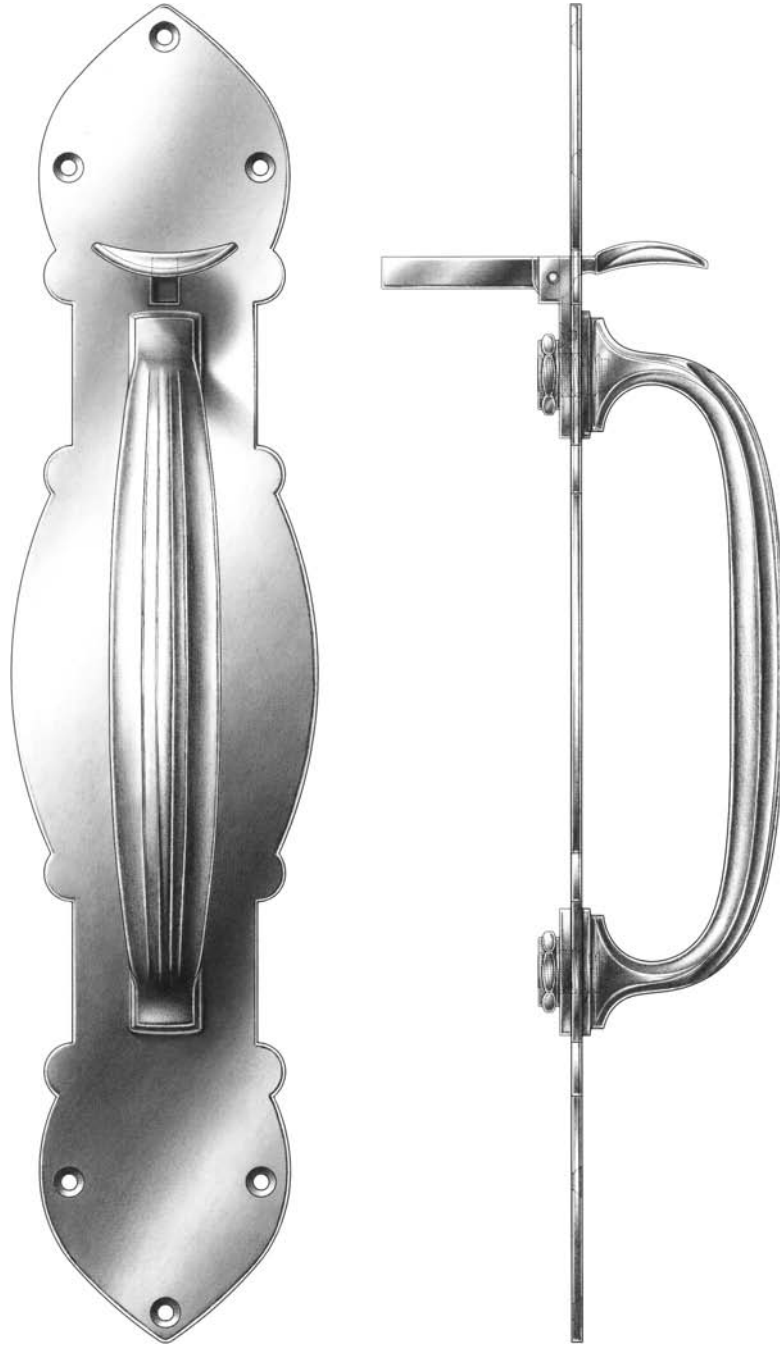

PREMIUM GRADE

Traditional Thumb Latch and Backplate

W.C. Vaughan Collection

7 inch Pull Handle (Center-to-Center) with 15 inch Backplate.
Solid Cast Brass Handle and Thumbpiece with Solid Machined Brass Backplate.
Standard, Custom Plated and Patinated Finishes Available.

1/2 Scale

FINE ARCHITECTURAL, BUILDERS' AND CABINETMAKERS' HARDWARE

E.R. BUTLER & CO.

DOOR KNOBS & ACCESSORIES

© E.R. BUTLER & CO. ALL RIGHTS RESERVED.

FINE ARCHITECTURAL, BUILDERS' AND CABINETMAKERS' HARDWARE

E. R. BUTLER & CO.

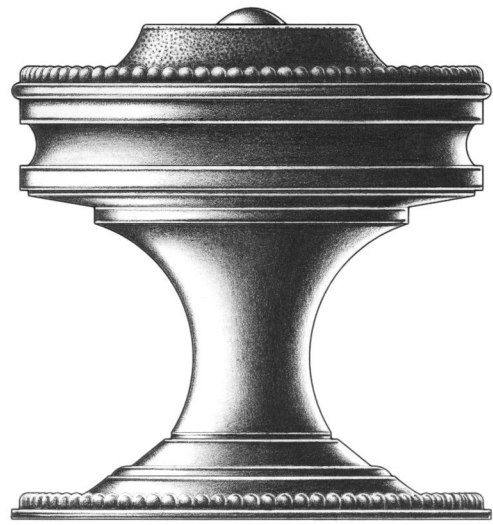
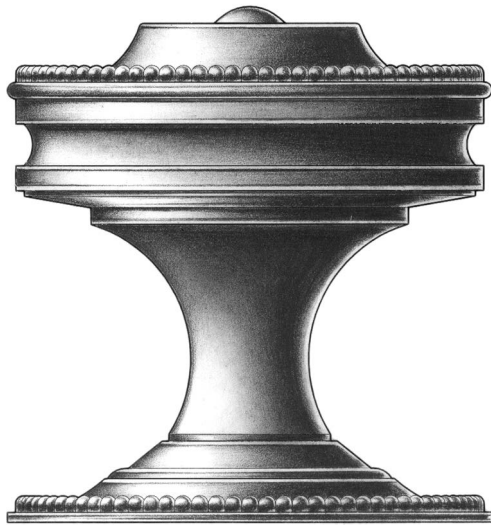
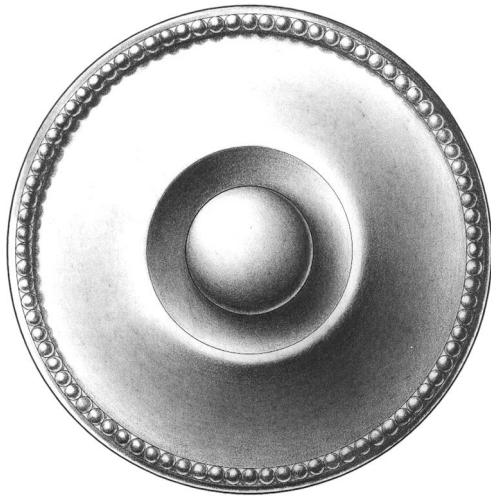

Plain

Hand Hammered

PREMIUM GRADE

Traditional BF Series Door Knobs and Roses

W.C. Vaughan Co. Collection

Available in $2\frac{3}{4}$, $2\frac{1}{2}$, $2\frac{1}{4}$, 2, and $1\frac{3}{4}$ inch Diameters for Doors ($2\frac{1}{2}$ in. Shown).
Available in 3 inch Diameters for Use as Center Knobs.
Also Available in $1\frac{1}{2}$, $1\frac{1}{4}$, 1, $\frac{3}{4}$ and $\frac{1}{2}$ inch Diameters for Cabinets and Fine Furniture.
Solid Turned Brass Knob and Rose.
Standard, Custom Plated and Patinated Finishes Available.

Full Scale

FINE ARCHITECTURAL, BUILDERS' AND CABINETMAKERS' HARDWARE

E. R. BUTLER & CO.

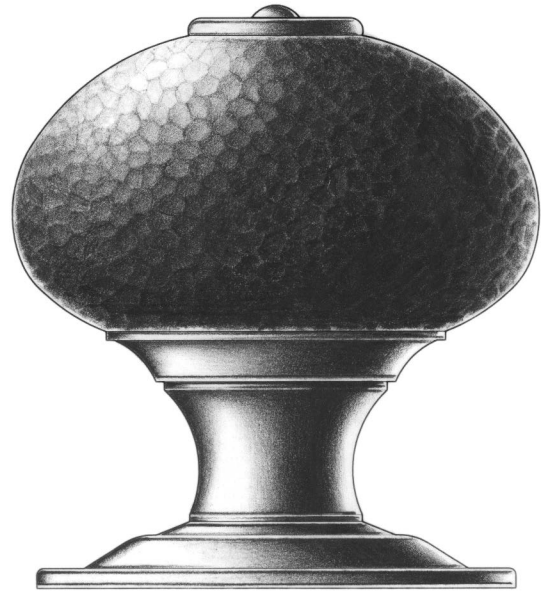
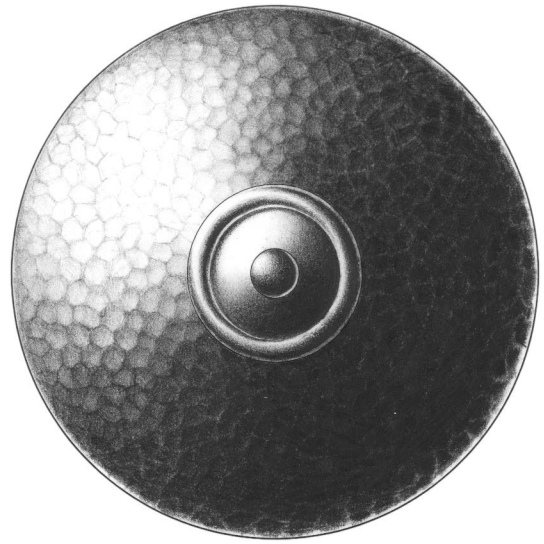
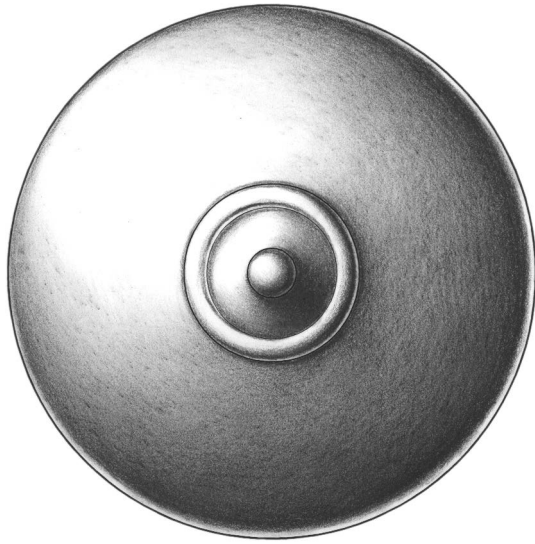

Plain

Hand Hammered

PREMIUM GRADE

Traditional BY Series Door Knobs and Roses

W.C. Vaughan Co. Collection

Available in $2\frac{3}{4}$, $2\frac{1}{2}$, $2\frac{1}{4}$, 2, and $1\frac{3}{4}$ inch Diameters for Doors ($2\frac{1}{2}$ in. Shown).
Available in 3 inch Diameters for Use as Center Knobs.
Also Available in $1\frac{1}{2}$, $1\frac{1}{4}$, 1, $\frac{3}{4}$ and $\frac{1}{2}$ inch Diameters for Cabinets and Fine Furniture.

Solid Turned Brass Knob and Rose.
Standard, Custom Plated and Patinated Finishes Available.

Full Scale

FINE ARCHITECTURAL, BUILDERS' AND CABINETMAKERS' HARDWARE

E. R. BUTLER & CO.

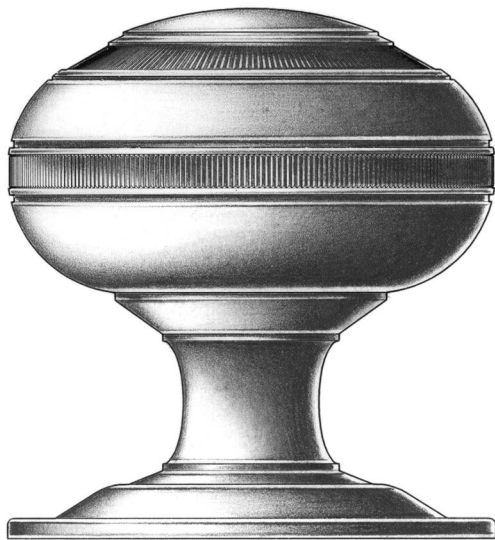
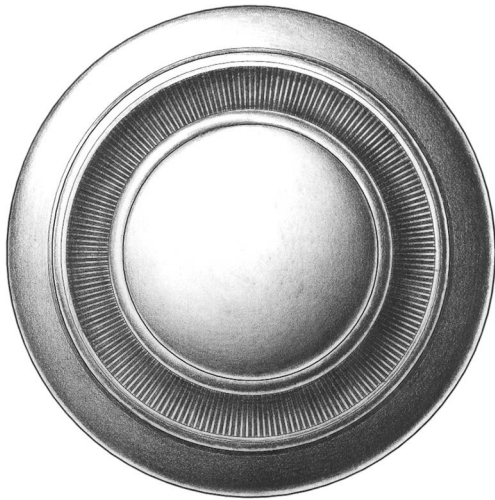

Plain

Hand Hammered

PREMIUM GRADE

Traditional DK Series Door Knobs and Roses

W.C. Vaughan Co. Collection

Available in 2 ³/₄, 2 ¹/₂, 2 ¹/₄, 2, and 1 ³/₄ inch Diameters for Doors (2 ¹/₂ in. Shown).
Available in 3 inch Diameters for Use as Center Knobs.
Also Available in 1 ¹/₂, 1 ¹/₄, 1, ³/₄ and ¹/₂ inch Diameters for Cabinets and Fine Furniture.
Solid Turned Brass Knob and Rose.
Standard, Custom Plated and Patinated Finishes Available.

Full Scale

FINE ARCHITECTURAL, BUILDERS' AND CABINETMAKERS' HARDWARE

E. R. BUTLER & CO.

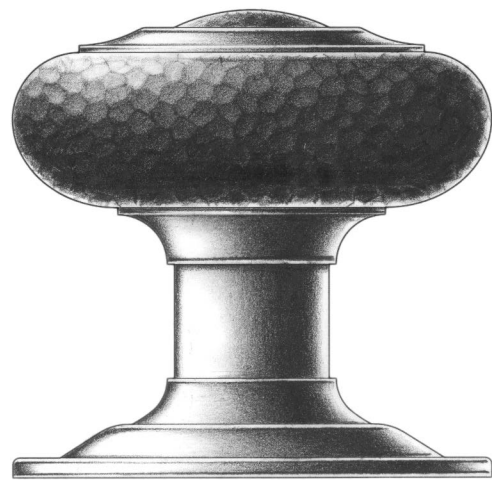
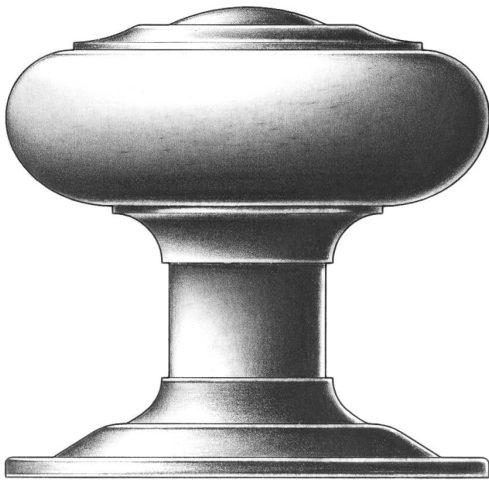
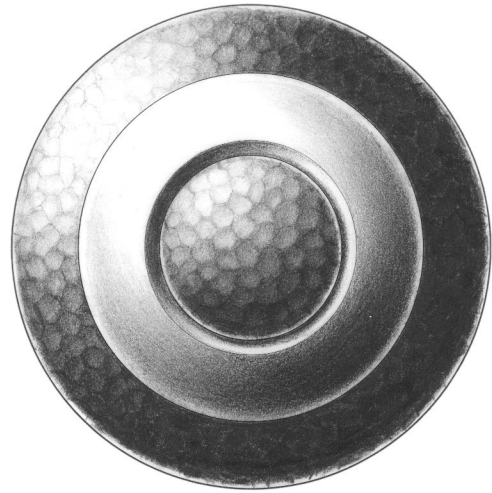

Plain

Hand Hammered

PREMIUM GRADE

Traditional DO Series Door Knobs and Roses

W.C. Vaughan Co. Collection

Available in $2\frac{3}{4}$, $2\frac{1}{2}$, $2\frac{1}{4}$, 2, and $1\frac{3}{4}$ inch Diameters for Doors ($2\frac{1}{2}$ in. Shown).
Available in 3 inch Diameters for Use as Center Knobs.
Also Available in $1\frac{1}{2}$, $1\frac{1}{4}$, 1, $\frac{3}{4}$ and $\frac{1}{2}$ inch Diameters for Cabinets and Fine Furniture.
Solid Turned Brass Knob and Rose.
Standard, Custom Plated and Patinated Finishes Available.

Full Scale

FINE ARCHITECTURAL, BUILDERS' AND CABINETMAKERS' HARDWARE

E. R. BUTLER & CO.

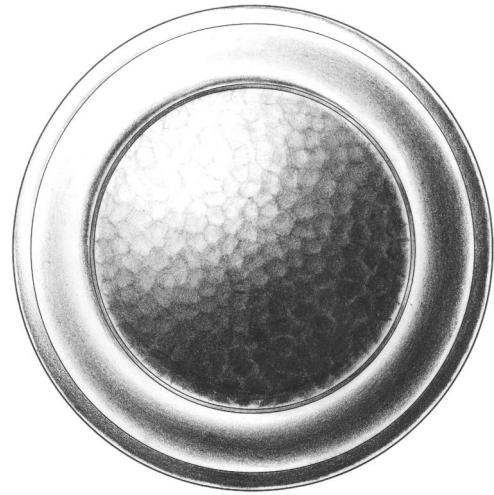

Plain

Hand Hammered

PREMIUM GRADE

Traditional EG Series Door Knobs and Roses

W.C. Vaughan Co. Collection

Available in $2\frac{3}{4}$, $2\frac{1}{2}$, $2\frac{1}{4}$, 2, and $1\frac{3}{4}$ inch Diameters for Doors ($2\frac{1}{2}$ in. Shown).
Available in 3 inch Diameters for Use as Center Knobs.
Also Available in $1\frac{1}{2}$, $1\frac{1}{4}$, 1, $\frac{3}{4}$ and $\frac{1}{2}$ inch Diameters for Cabinets and Fine Furniture.
Solid Turned Brass Knob and Rose.
Standard, Custom Plated and Patinated Finishes Available.

Full Scale

FINE ARCHITECTURAL, BUILDERS' AND CABINETMAKERS' HARDWARE

E. R. BUTLER & CO.

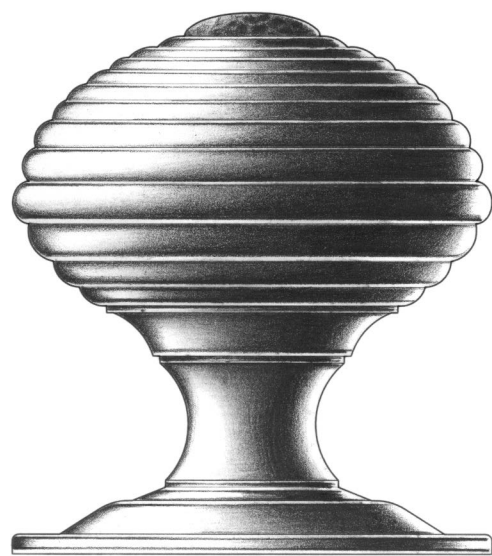
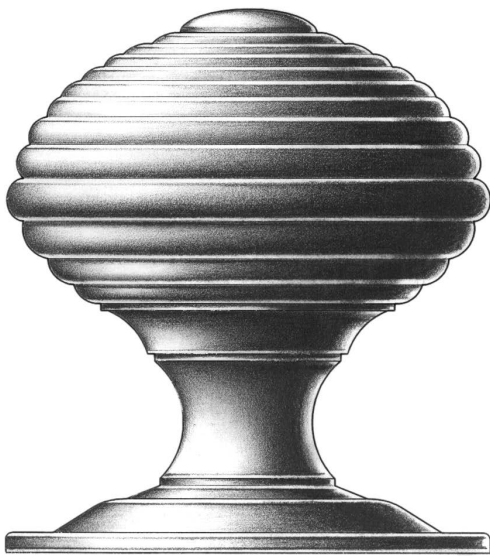
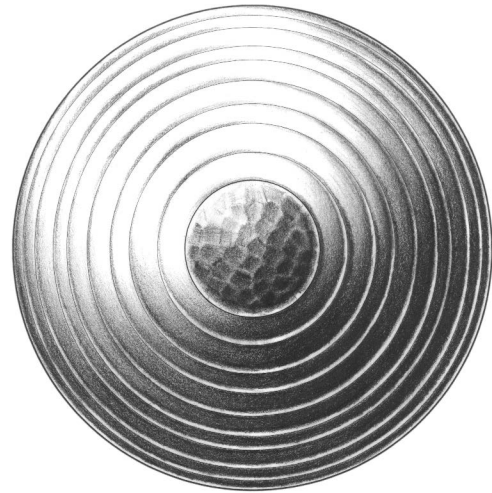
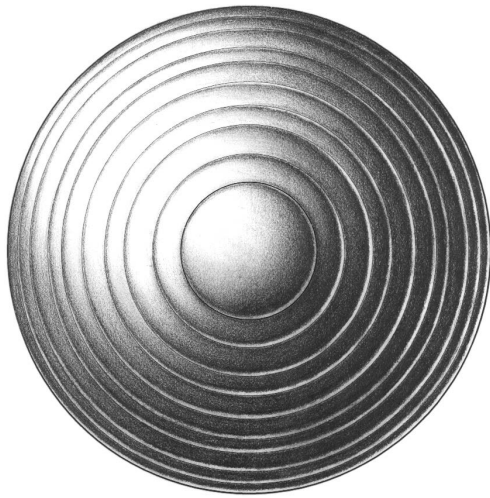

Plain

Hand Hammered

PREMIUM GRADE

Traditional EN Series Door Knobs and Roses

W.C. Vaughan Co. Collection

Available in 2 ³/₄, 2 ¹/₂, 2 ¹/₄, 2, and 1 ³/₄ inch Diameters for Doors (2 ¹/₂ in. Shown).
Available in 3 inch Diameters for Use as Center Knobs.
Also Available in 1 ¹/₂, 1 ¹/₄, 1, ³/₄ and ¹/₂ inch Diameters for Cabinets and Fine Furniture.
Solid Turned Brass Knob and Rose.
Standard, Custom Plated and Patinated Finishes Available.

Full Scale

FINE ARCHITECTURAL, BUILDERS' AND CABINETMAKERS' HARDWARE

E. R. BUTLER & CO.

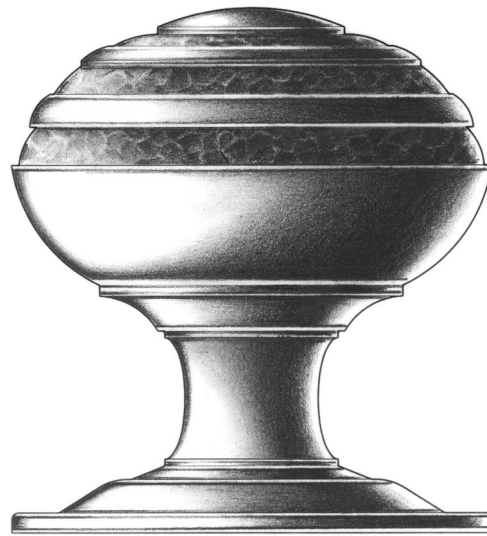

Plain

Hand Hammered

PREMIUM GRADE

Traditional FR Series Door Knobs and Roses

W.C. Vaughan Co. Collection

Available in $2\frac{3}{4}$, $2\frac{1}{2}$, $2\frac{1}{4}$, 2, and $1\frac{3}{4}$ inch Diameters for Doors ($2\frac{1}{2}$ in. Shown).
Available in 3 inch Diameters for Use as Center Knobs.
Also Available in $1\frac{1}{2}$, $1\frac{1}{4}$, 1, $\frac{3}{4}$ and $\frac{1}{2}$ inch Diameters for Cabinets and Fine Furniture.

Solid Turned Brass Knob and Rose.
Standard, Custom Plated and Patinated Finishes Available.

Full Scale

FINE ARCHITECTURAL, BUILDERS' AND CABINETMAKERS' HARDWARE

E. R. BUTLER & CO.

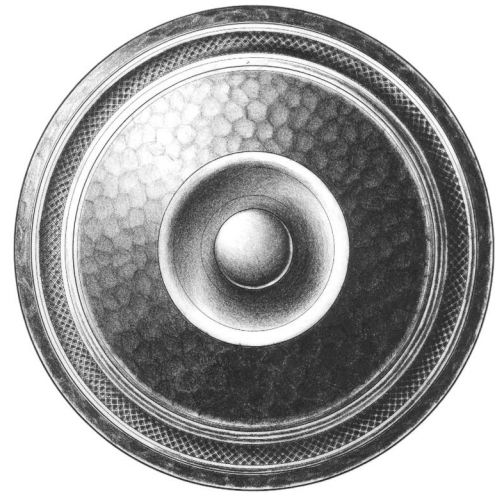

Plain

Hand Hammered

PREMIUM GRADE

Traditional KB Series Door Knobs and Roses

W.C. Vaughan Co. Collection

Available in $2\frac{3}{4}$, $2\frac{1}{2}$, $2\frac{1}{4}$, 2, and $1\frac{3}{4}$ inch Diameters for Doors ($2\frac{1}{2}$ in. Shown).
Available in 3 inch Diameters for Use as Center Knobs.
Also Available in $1\frac{1}{2}$, $1\frac{1}{4}$, 1, $\frac{3}{4}$ and $\frac{1}{2}$ inch Diameters for Cabinets and Fine Furniture.
Solid Turned Brass Knob and Rose.
Standard, Custom Plated and Patinated Finishes Available.

Full Scale

FINE ARCHITECTURAL, BUILDERS' AND CABINETMAKERS' HARDWARE

E. R. BUTLER & CO.

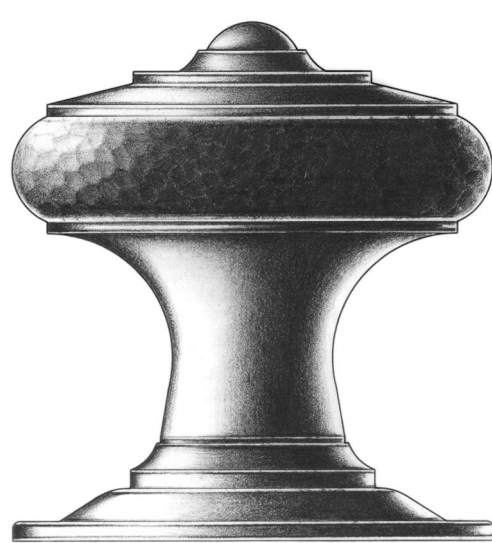
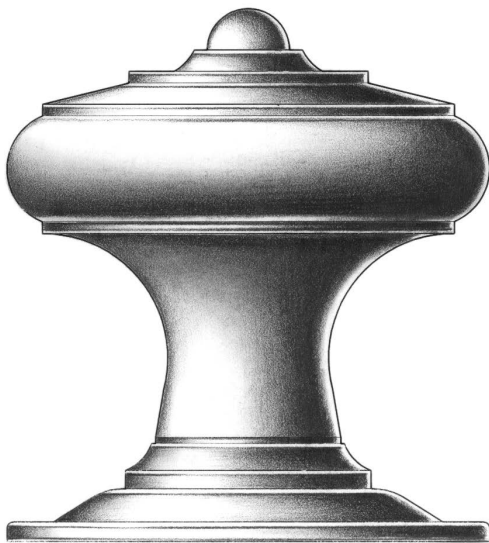
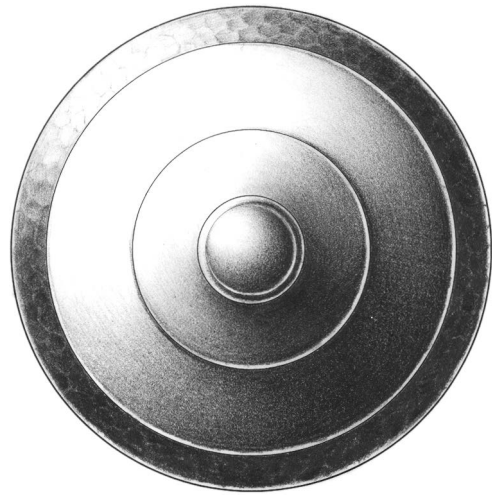

Plain

Hand Hammered

PREMIUM GRADE

Traditional KH Series Door Knobs and Roses

W.C. Vaughan Co. Collection

Available in $2\frac{3}{4}$, $2\frac{1}{2}$, $2\frac{1}{4}$, 2, and $1\frac{3}{4}$ inch Diameters for Doors ($2\frac{1}{2}$ in. Shown).
Available in 3 inch Diameters for Use as Center Knobs.
Also Available in $1\frac{1}{2}$, $1\frac{1}{4}$, 1, $\frac{3}{4}$ and $\frac{1}{2}$ inch Diameters for Cabinets and Fine Furniture.
Solid Turned Brass Knob and Rose.
Standard, Custom Plated and Patinated Finishes Available.

Full Scale

FINE ARCHITECTURAL, BUILDERS' AND CABINETMAKERS' HARDWARE

E. R. BUTLER & CO.



Plain

Hand Hammered

PREMIUM GRADE

Traditional KR Series Door Knobs and Roses

W.C. Vaughan Co. Collection

Available in $2\frac{3}{4}$, $2\frac{1}{2}$, $2\frac{1}{4}$, 2, and $1\frac{3}{4}$ inch Diameters for Doors ($2\frac{1}{2}$ in. Shown).
Available in 3 inch Diameters for Use as Center Knobs.
Also Available in $1\frac{1}{2}$, $1\frac{1}{4}$, $1\frac{3}{4}$ and $\frac{1}{2}$ inch Diameters for Cabinets and Fine Furniture.
Solid Turned Brass Knob and Rose.
Standard, Custom Plated and Patinated Finishes Available.

Full Scale

FINE ARCHITECTURAL, BUILDERS' AND CABINETMAKERS' HARDWARE

E. R. BUTLER & CO.

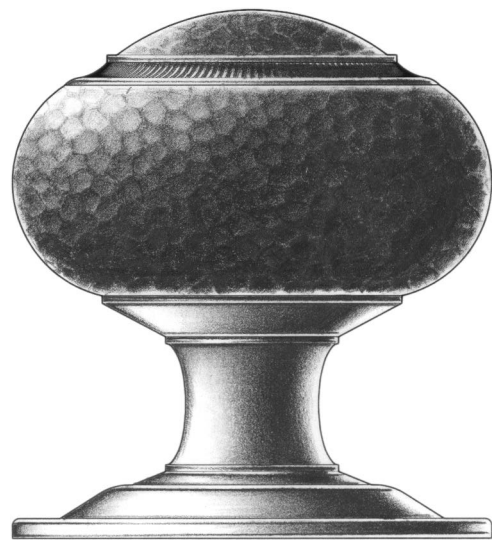
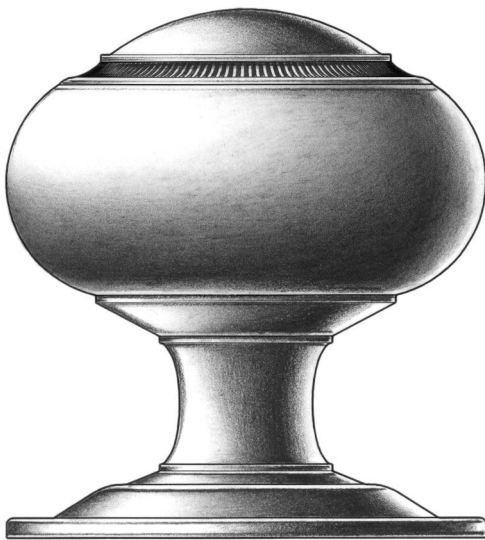
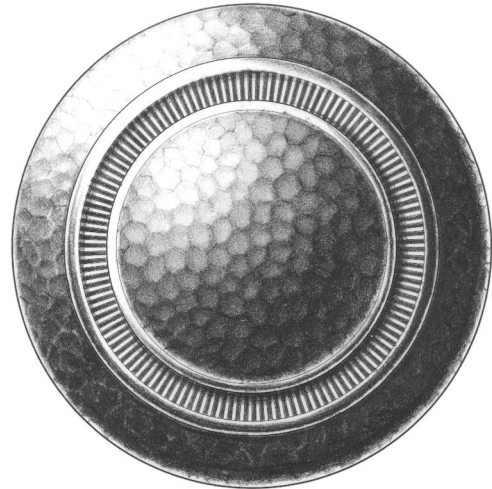
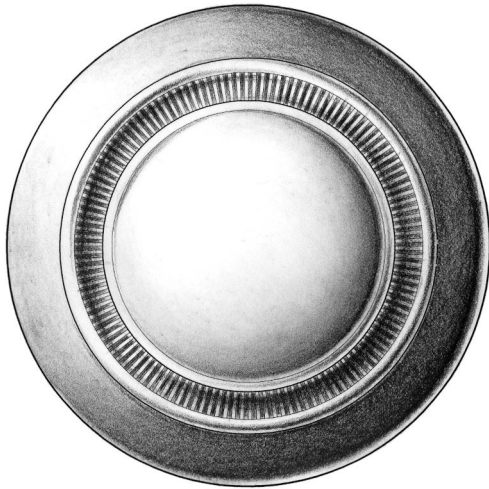

Plain

Hand Hammered

PREMIUM GRADE

Traditional KY Series Door Knobs and Roses

W.C. Vaughan Co. Collection

Available in 2 ³/₄, 2 ¹/₂, 2 ¹/₄, 2, and 1 ³/₄ inch Diameters for Doors (2 ¹/₂ in. Shown).
Available in 3 inch Diameters for Use as Center Knobs.
Also Available in 1 ¹/₂, 1 ¹/₄, 1, ³/₄ and ¹/₂ inch Diameters for Cabinets and Fine Furniture.

Solid Turned Brass Knob and Rose.
Standard, Custom Plated and Patinated Finishes Available.

Full Scale

FINE ARCHITECTURAL, BUILDERS' AND CABINETMAKERS' HARDWARE

E. R. BUTLER & CO.

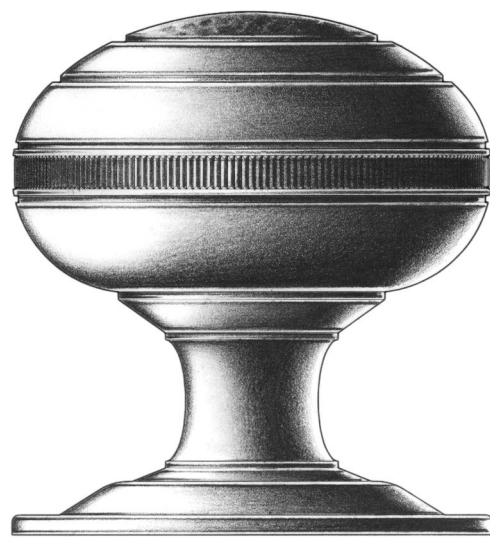
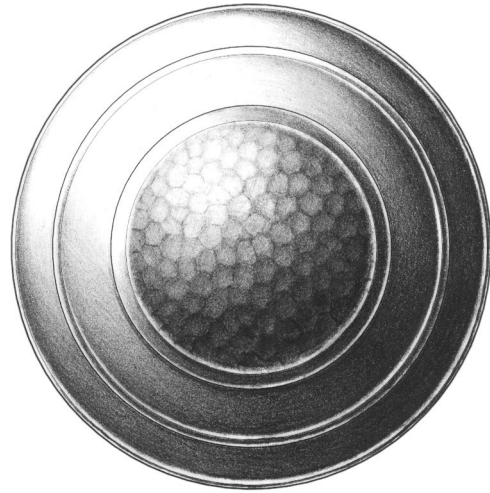
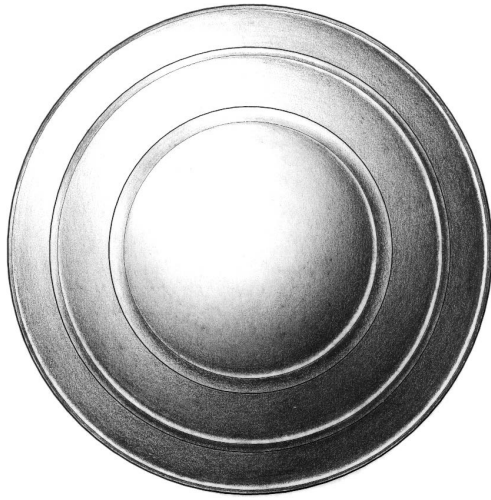

Plain

Hand Hammered

PREMIUM GRADE

Traditional LK Series Door Knobs and Roses

W.C. Vaughan Co. Collection

Available in 2 ³/₄, 2 ¹/₂, 2 ¹/₄, 2, and 1 ³/₄ inch Diameters for Doors (2 ¹/₂ in. Shown).
Available in 3 inch Diameters for Use as Center Knobs.
Also Available in 1 ¹/₂, 1 ¹/₄, 1, ³/₄ and ¹/₂ inch Diameters for Cabinets and Fine Furniture.
Solid Turned Brass Knob and Rose.
Standard, Custom Plated and Patinated Finishes Available.

Full Scale

FINE ARCHITECTURAL, BUILDERS' AND CABINETMAKERS' HARDWARE

E. R. BUTLER & CO.

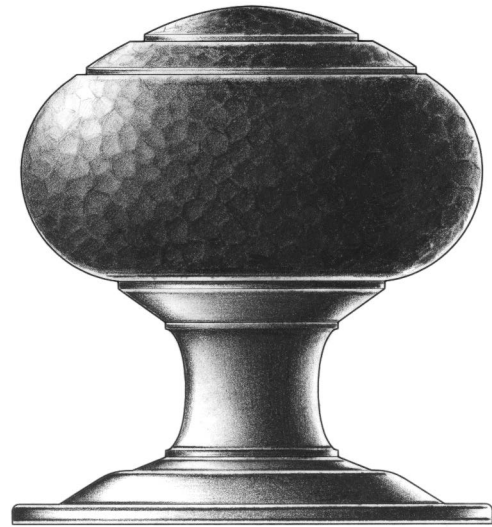
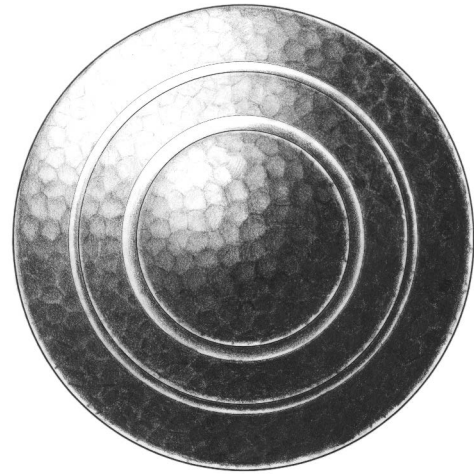

Plain

Hand Hammered

PREMIUM GRADE

Traditional LO Series Door Knobs and Roses

W.C. Vaughan Co. Collection

Available in $2\frac{3}{4}$, $2\frac{1}{2}$, $2\frac{1}{4}$, 2, and $1\frac{3}{4}$ inch Diameters for Doors ($2\frac{1}{2}$ in. Shown).
Available in 3 inch Diameters for Use as Center Knobs.
Also Available in $1\frac{1}{2}$, $1\frac{1}{4}$, $1\frac{3}{4}$ and $\frac{1}{2}$ inch Diameters for Cabinets and Fine Furniture.
Solid Turned Brass Knob and Rose.
Standard, Custom Plated and Patinated Finishes Available.

Full Scale

FINE ARCHITECTURAL, BUILDERS' AND CABINETMAKERS' HARDWARE

E. R. BUTLER & CO.

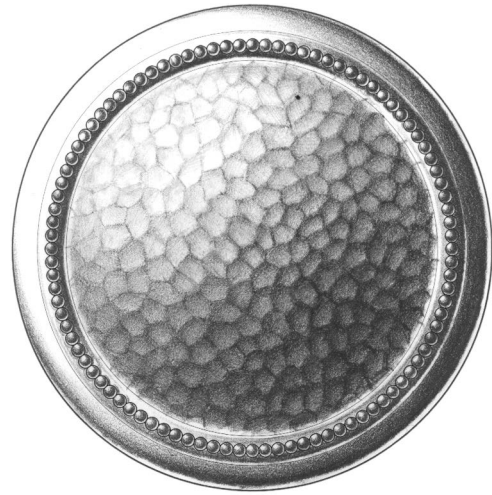
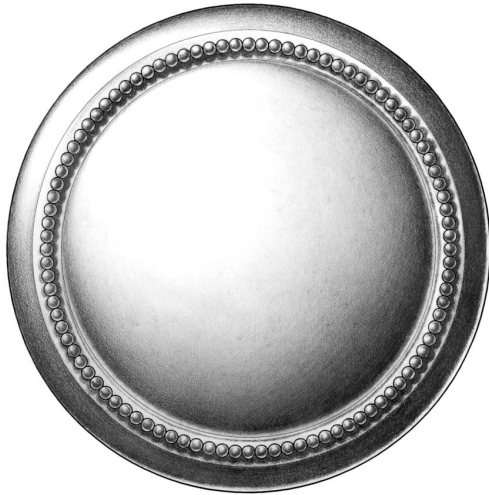

Plain

Hand Hammered

PREMIUM GRADE

Traditional NB Series Door Knobs and Roses

W.C. Vaughan Co. Collection

Available in $2\frac{3}{4}$, $2\frac{1}{2}$, $2\frac{1}{4}$, 2, and $1\frac{3}{4}$ inch Diameters for Doors ($2\frac{1}{2}$ in. Shown).
Available in 3 inch Diameters for Use as Center Knobs.
Also Available in $1\frac{1}{2}$, $1\frac{1}{4}$, 1, $\frac{3}{4}$ and $\frac{1}{2}$ inch Diameters for Cabinets and Fine Furniture.
Solid Turned Brass Knob and Rose.
Standard, Custom Plated and Patinated Finishes Available.

Full Scale

FINE ARCHITECTURAL, BUILDERS' AND CABINETMAKERS' HARDWARE

E. R. BUTLER & CO.

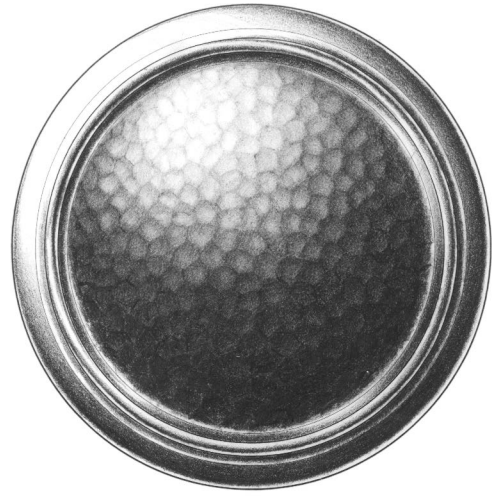

Plain

Hand Hammered

PREMIUM GRADE

Traditional NG Series Door Knobs and Roses

W.C. Vaughan Co. Collection

Available in $2\frac{3}{4}$, $2\frac{1}{2}$, $2\frac{1}{4}$, 2, and $1\frac{3}{4}$ inch Diameters for Doors ($2\frac{1}{2}$ in. Shown).
Available in 3 inch Diameters for Use as Center Knobs.
Also Available in $1\frac{1}{2}$, $1\frac{1}{4}$, 1, $\frac{3}{4}$ and $\frac{1}{2}$ inch Diameters for Cabinets and Fine Furniture.
Solid Turned Brass Knob and Rose.
Standard, Custom Plated and Patinated Finishes Available.

Full Scale

FINE ARCHITECTURAL, BUILDERS' AND CABINETMAKERS' HARDWARE

E. R. BUTLER & CO.



Plain

Hand Hammered

PREMIUM GRADE

Traditional NK Series Door Knobs and Roses

W.C. Vaughan Co. Collection

Available in $2\frac{3}{4}$, $2\frac{1}{2}$, $2\frac{1}{4}$, 2, and $1\frac{3}{4}$ inch Diameters for Doors ($2\frac{1}{2}$ in. Shown).
Available in 3 inch Diameters for Use as Center Knobs.
Also Available in $1\frac{1}{2}$, $1\frac{1}{4}$, 1, $\frac{3}{4}$ and $\frac{1}{2}$ inch Diameters for Cabinets and Fine Furniture.
Solid Turned Brass Knob and Rose.
Standard, Custom Plated and Patinated Finishes Available.

Full Scale

FINE ARCHITECTURAL, BUILDERS' AND CABINETMAKERS' HARDWARE

E. R. BUTLER & CO.

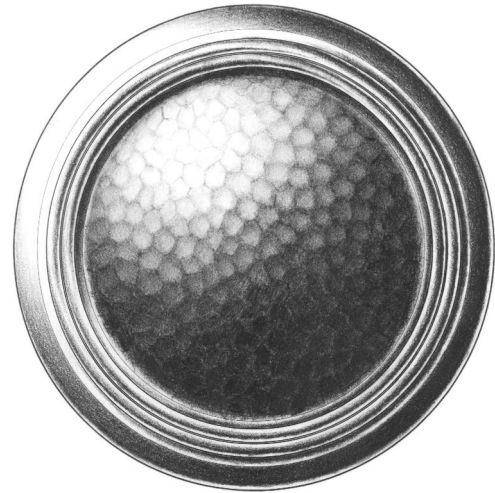

Plain

Hand Hammered

PREMIUM GRADE

Traditional NN Series Door Knobs and Roses

W.C. Vaughan Co. Collection

Available in 2 ³/₄, 2 ¹/₂, 2 ¹/₄, 2, and 1 ³/₄ inch Diameters for Doors (2 ¹/₂ in. Shown).
Available in 3 inch Diameters for Use as Center Knobs.
Also Available in 1 ¹/₂, 1 ¹/₄, 1, ³/₄ and ¹/₂ inch Diameters for Cabinets and Fine Furniture.
Solid Turned Brass Knob and Rose.
Standard, Custom Plated and Patinated Finishes Available.

Full Scale

FINE ARCHITECTURAL, BUILDERS' AND CABINETMAKERS' HARDWARE

E. R. BUTLER & CO.

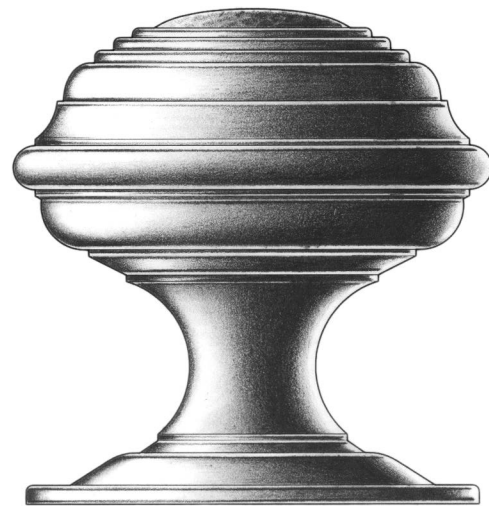
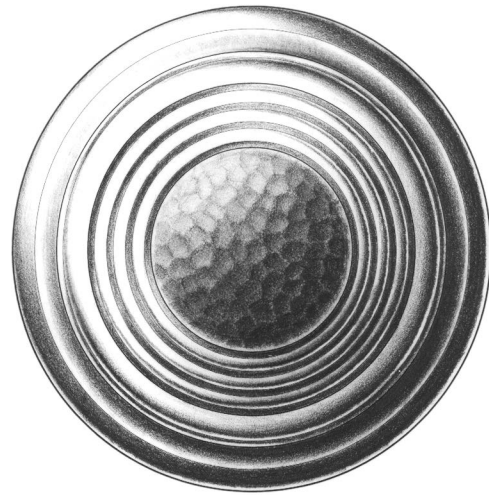
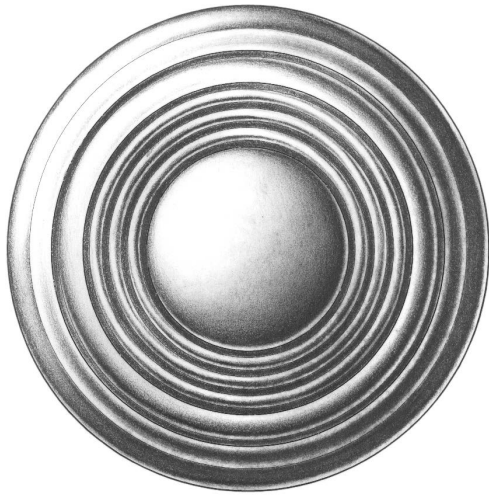

Plain

Hand Hammered

PREMIUM GRADE

Traditional OG Series Door Knobs and Roses

W.C. Vaughan Co. Collection

Available in 2 ³/₄, 2 ¹/₂, 2 ¹/₄, 2, and 1 ³/₄ inch Diameters for Doors (2 ¹/₂ in. Shown).
Available in 3 inch Diameters for Use as Center Knobs.
Also Available in 1 ¹/₂, 1 ¹/₄, 1, ³/₄ and ¹/₂ inch Diameters for Cabinets and Fine Furniture.
Solid Turned Brass Knob and Rose.
Standard, Custom Plated and Patinated Finishes Available.

Full Scale

FINE ARCHITECTURAL, BUILDERS' AND CABINETMAKERS' HARDWARE

E. R. BUTLER & CO.

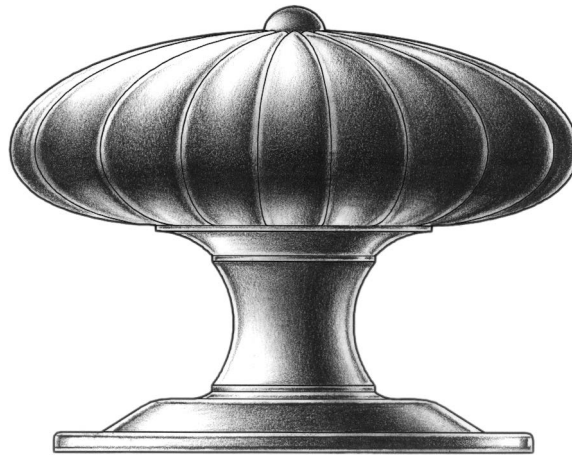
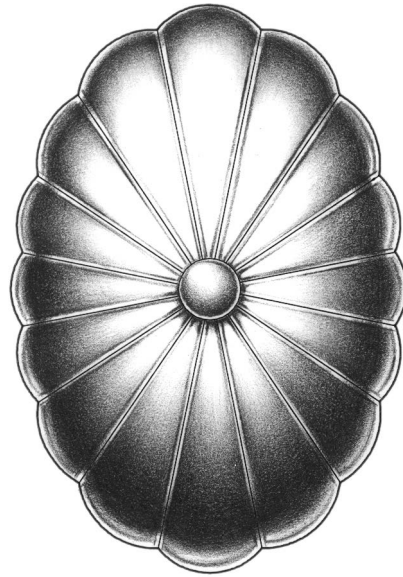

PREMIUM GRADE

Traditional OM Series Door Knobs and Roses

W.C. Vaughan Co. Collection

Available in 2³/₄, 2¹/₂, 2¹/₄, 2, and 1³/₄ inch Sizes (Nominal) for Doors (2¹/₂ in. Shown).

Available in 3 inch Sizes (Nominal) for Use as Center Knobs.

Also Available in 1¹/₂, 1¹/₄, 1, ³/₄ and ¹/₂ inch Sizes (Nominal) for Cabinets and Fine Furniture.

Solid Turned Brass Knob and Rose.

Standard, Custom Plated and Patinated Finishes Available.

Full Scale

FINE ARCHITECTURAL, BUILDERS' AND CABINETMAKERS' HARDWARE

E. R. BUTLER & CO.

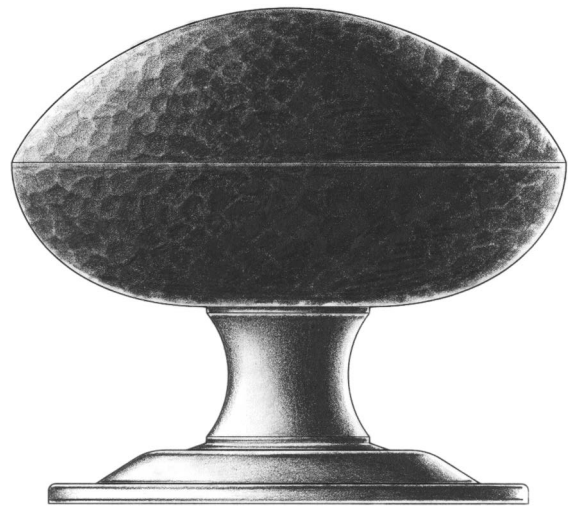
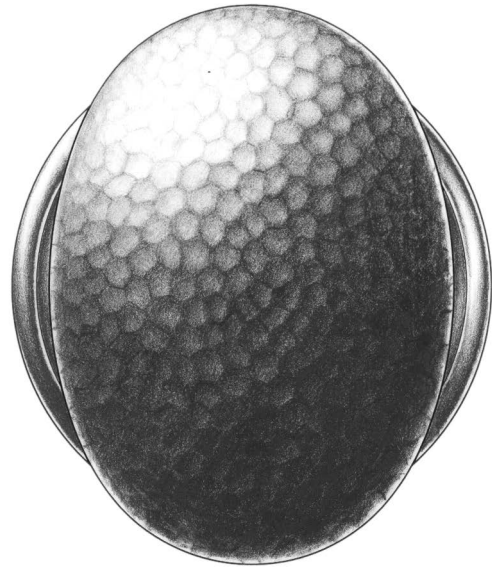
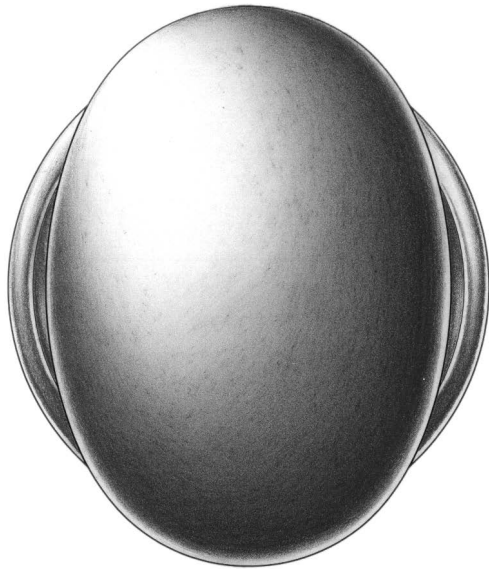

Plain

Hand Hammered

PREMIUM GRADE

Traditional OV Series Door Knobs and Roses

W.C. Vaughan Co. Collection

Available in $2\frac{3}{4}$, $2\frac{1}{2}$, $2\frac{1}{4}$, 2, and $1\frac{3}{4}$ inch Sizes (Nominal) for Doors ($2\frac{1}{2}$ in. Shown).
Available in 3 inch Sizes (Nominal) for Use as Center Knobs.
Also Available in $1\frac{1}{2}$, $1\frac{1}{4}$, 1, $\frac{3}{4}$ and $\frac{1}{2}$ inch Sizes (Nominal) for Cabinets and Fine Furniture.
Solid Turned Brass Knob and Rose.
Standard, Custom Plated and Patinated Finishes Available.

Full Scale

FINE ARCHITECTURAL, BUILDERS' AND CABINETMAKERS' HARDWARE

E. R. BUTLER & CO.



Plain

Hand Hammered

PREMIUM GRADE

Traditional RB Series Door Knobs and Roses

W.C. Vaughan Co. Collection

Available in $2\frac{3}{4}$, $2\frac{1}{2}$, $2\frac{1}{4}$, 2, and $1\frac{3}{4}$ inch Diameters for Doors ($2\frac{1}{2}$ in. Shown).
Available in 3 inch Diameters for Use as Center Knobs.
Also Available in $1\frac{1}{2}$, $1\frac{1}{4}$, 1, $\frac{3}{4}$ and $\frac{1}{2}$ inch Diameters for Cabinets and Fine Furniture.

Solid Turned Brass Knob and Rose.
Standard, Custom Plated and Patinated Finishes Available.

Full Scale

FINE ARCHITECTURAL, BUILDERS' AND CABINETMAKERS' HARDWARE

E. R. BUTLER & CO.

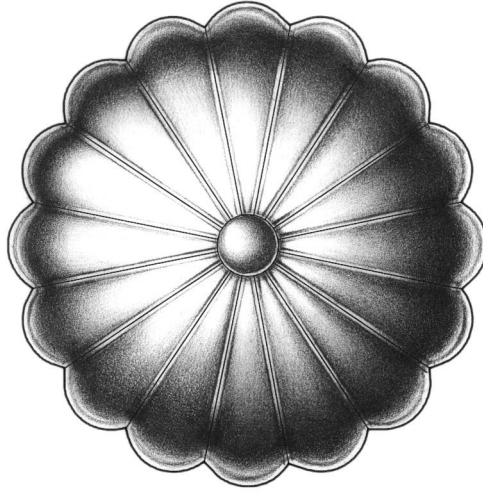

PREMIUM GRADE

Traditional RM Series Door Knobs and Roses

W.C. Vaughan Co. Collection

Available in $2\frac{3}{4}$, $2\frac{1}{2}$, $2\frac{1}{4}$, 2, and $1\frac{3}{4}$ inch Diameters for Doors ($2\frac{1}{2}$ in. Shown).

Available in 3 inch Diameters for Use as Center Knobs.

Also Available in $1\frac{1}{2}$, $1\frac{1}{4}$, $1\frac{3}{4}$ and $\frac{1}{2}$ inch Diameters for Cabinets and Fine Furniture.

Solid Turned Brass Knob and Rose.

Standard, Custom Plated and Patinated Finishes Available.

Full Scale

FINE ARCHITECTURAL, BUILDERS' AND CABINETMAKERS' HARDWARE

E. R. BUTLER & CO.

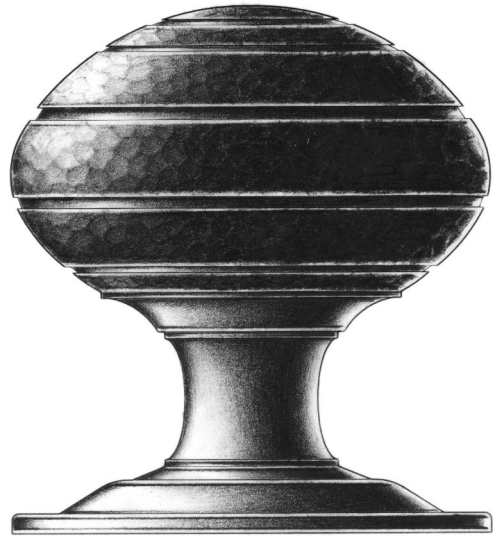
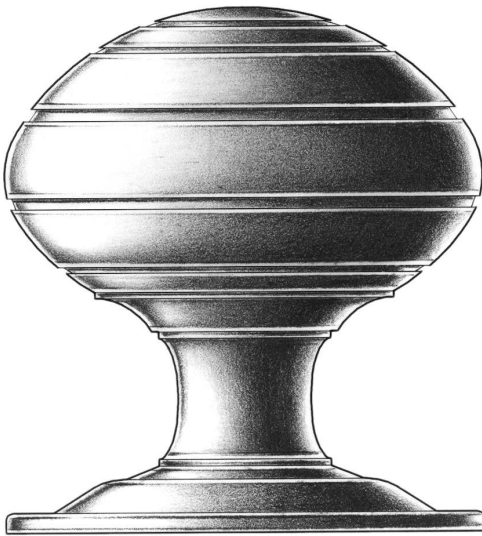
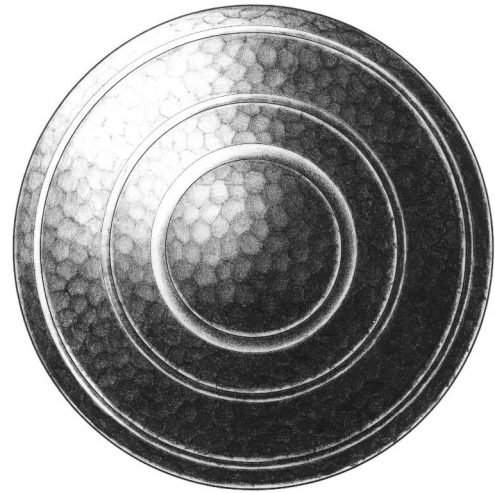
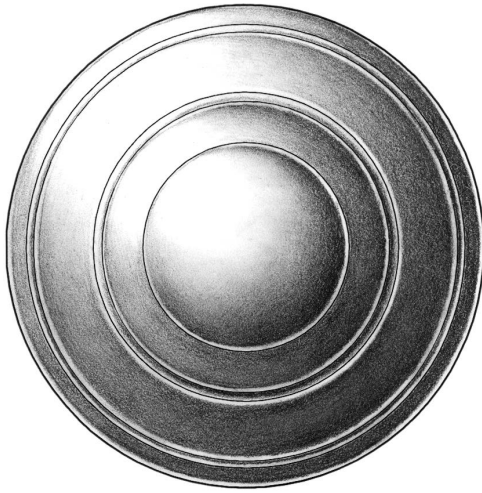

Plain

Hand Hammered

PREMIUM GRADE

Traditional SM Series Door Knobs and Roses

W.C. Vaughan Co. Collection

Available in $2\frac{3}{4}$, $2\frac{1}{2}$, $2\frac{1}{4}$, 2, and $1\frac{3}{4}$ inch Diameters for Doors ($2\frac{1}{2}$ in. Shown).
Available in 3 inch Diameters for Use as Center Knobs.
Also Available in $1\frac{1}{2}$, $1\frac{1}{4}$, 1, $\frac{3}{4}$ and $\frac{1}{2}$ inch Diameters for Cabinets and Fine Furniture.
Solid Turned Brass Knob and Rose.
Standard, Custom Plated and Patinated Finishes Available.

Full Scale

FINE ARCHITECTURAL, BUILDERS' AND CABINETMAKERS' HARDWARE

E. R. BUTLER & CO.

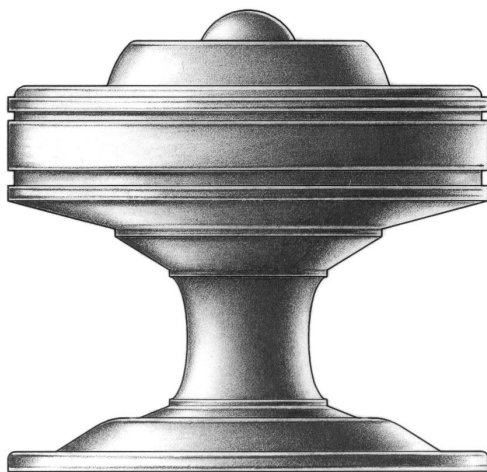

Plain

Hand Hammered

PREMIUM GRADE

Traditional VA Series Door Knobs and Roses

W.C. Vaughan Co. Collection

Available in $2\frac{3}{4}$, $2\frac{1}{2}$, $2\frac{1}{4}$, 2, and $1\frac{3}{4}$ inch Diameters for Doors ($2\frac{1}{2}$ in. Shown).
Available in 3 inch Diameters for Use as Center Knobs.
Also Available in $1\frac{1}{2}$, $1\frac{1}{4}$, 1, $\frac{3}{4}$ and $\frac{1}{2}$ inch Diameters for Cabinets and Fine Furniture.
Solid Turned Brass Knob and Rose.
Standard, Custom Plated and Patinated Finishes Available.

Full Scale

FINE ARCHITECTURAL, BUILDERS' AND CABINETMAKERS' HARDWARE

E. R. BUTLER & CO.

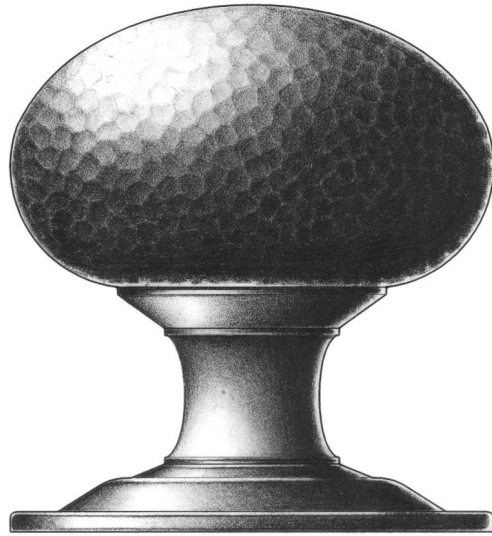
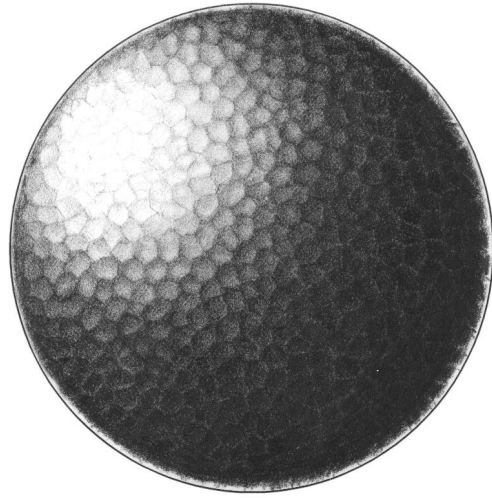
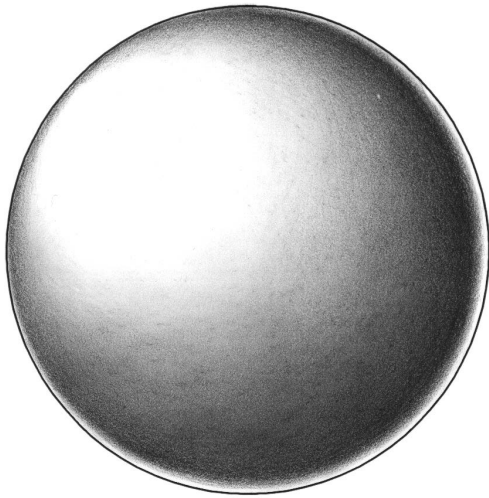

Plain

Hand Hammered

PREMIUM GRADE

Traditional VC Series Door Knobs and Roses

W.C. Vaughan Co. Collection

Available in $2\frac{3}{4}$, $2\frac{1}{2}$, $2\frac{1}{4}$, 2, and $1\frac{3}{4}$ inch Diameters for Doors ($2\frac{1}{2}$ in. Shown).
Available in 3 inch Diameters for Use as Center Knobs.
Also Available in $1\frac{1}{2}$, $1\frac{1}{4}$, 1, $\frac{3}{4}$ and $\frac{1}{2}$ inch Diameters for Cabinets and Fine Furniture.
Solid Turned Brass Knob and Rose.
Standard, Custom Plated and Patinated Finishes Available.

Full Scale

FINE ARCHITECTURAL, BUILDERS' AND CABINETMAKERS' HARDWARE

E. R. BUTLER & CO.

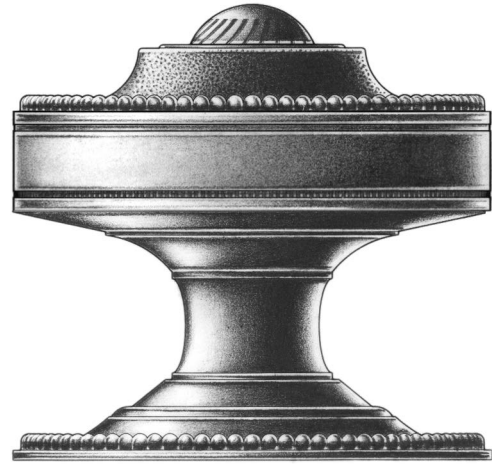
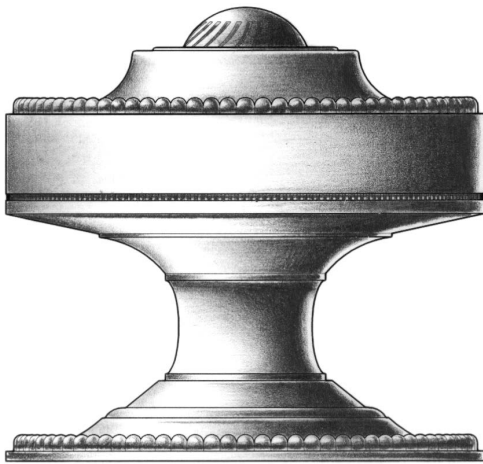

Plain

Hand Hammered

PREMIUM GRADE

Traditional VF Series Door Knobs and Roses

W.C. Vaughan Co. Collection

Available in $2\frac{3}{4}$, $2\frac{1}{2}$, $2\frac{1}{4}$, 2, and $1\frac{3}{4}$ inch Diameters for Doors ($2\frac{1}{2}$ in. Shown).
Available in 3 inch Diameters for Use as Center Knobs.
Also Available in $1\frac{1}{2}$, $1\frac{1}{4}$, 1, $\frac{3}{4}$ and $\frac{1}{2}$ inch Diameters for Cabinets and Fine Furniture.

Solid Turned Brass Knob and Rose.
Standard, Custom Plated and Patinated Finishes Available.

Full Scale

FINE ARCHITECTURAL, BUILDERS' AND CABINETMAKERS' HARDWARE

E. R. BUTLER & CO.

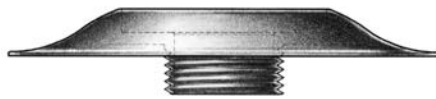

plain



ridged

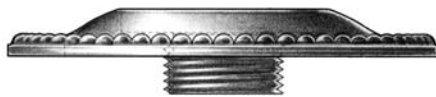

beaded



knurled

PREMIUM GRADE

Traditional Rose Escutcheons

V.C. Vaughan Co. Collection

For Use with W.C. Vaughan Door Knobs and Levers.

Available in 3, 2 ³/₄, 2 ¹/₂, 2 ¹/₄, 2, and 1 ³/₄ inch Diameters for Doors (2 ¹/₂ in. Shown).

Also Available in 1 ¹/₂, 1 ¹/₄, 1, ³/₄ and ¹/₂ inch Diameters for Cabinets and Fine Furniture.

Solid Turned Brass.

Standard, Custom Plated and Patinated Finishes Available.

Full Scale

FINE ARCHITECTURAL, BUILDERS' AND CABINETMAKERS' HARDWARE

E. R. BUTLER & CO.



PREMIUM GRADE

Traditional Beveled Escutcheon Plates
W.C. Vaughan Co. Collection

For Use with $1\frac{3}{4}$ through $2\frac{3}{4}$ inch W.C. Vaughan Door Knobs.
Also for Use with Sizes S, M and L W.C. Vaughan Lever Handles.

$7 \times 2\frac{1}{4}$ inch Escutcheon Plate with $1\frac{3}{4}$ inch Rose.

Solid Machined Brass.

Standard, Custom Plated and Patinated Finishes Available.

Full Scale

FINE ARCHITECTURAL, BUILDERS' AND CABINETMAKERS' HARDWARE

E. R. BUTLER & CO.

CYLINDER COVERS & RINGS

© E. R. BUTLER & CO. ALL RIGHTS RESERVED.

FINE ARCHITECTURAL, BUILDERS' AND CABINETMAKERS' HARDWARE

E. R. BUTLER & CO.

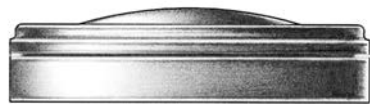
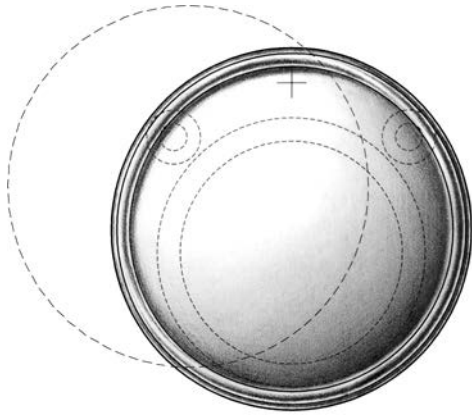

fig. ng

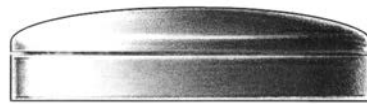
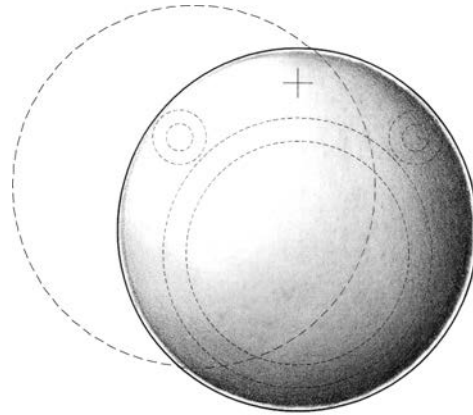

fig. vc

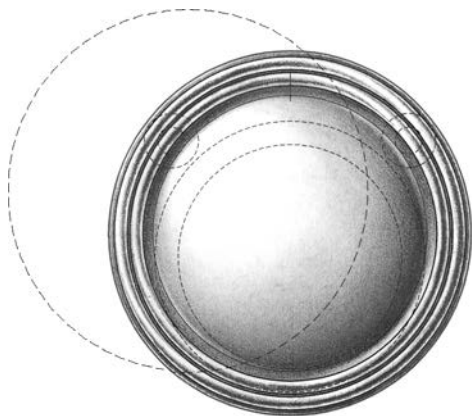

fig. nm

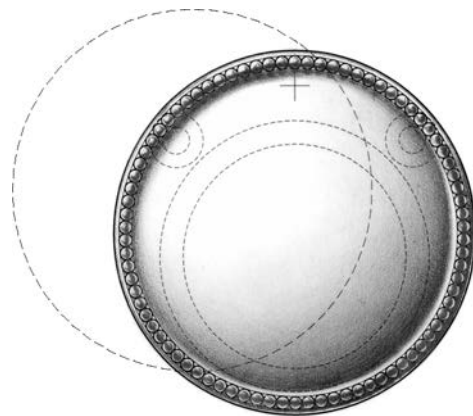

fig. nb

PREMIUM GRADE

Cylinder Cover

W.C. Vaughan Co. Collection

For Use with Rim and Mortise Cylinders.
Available in 1 7/8 inch Diameters for Doors.
Regularly Furnished with Compression Springs and No. 4 x 5/8" FHWS.
Solid Turned Brass Escutcheon and Cover.
Standard, Custom Plated and Patinated Finishes Available.

Full Scale

FINE ARCHITECTURAL, BUILDERS' AND CABINETMAKERS' HARDWARE

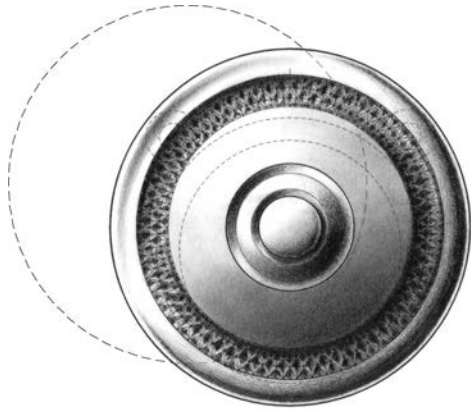

fig. kb

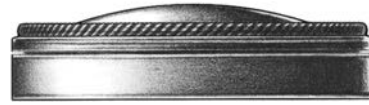
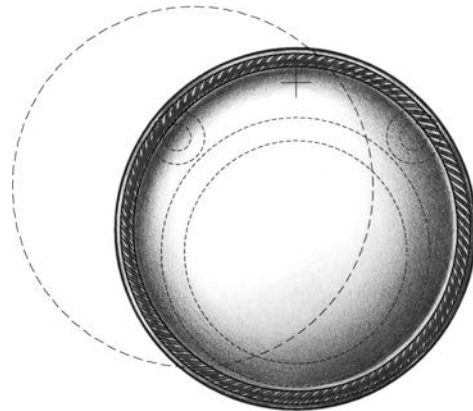

fig. nk

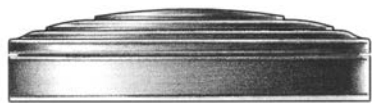
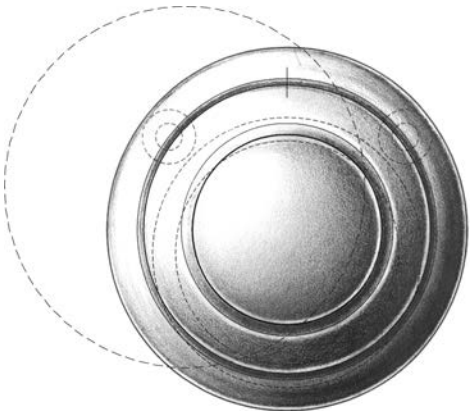

fig. lo

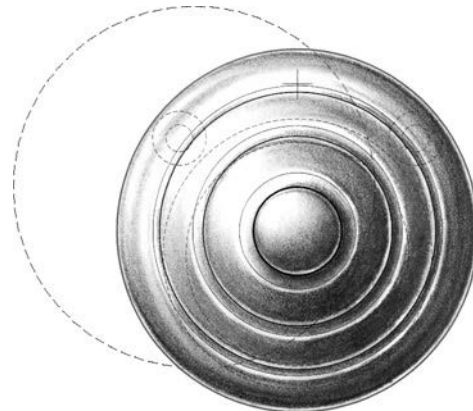

fig. sm

PREMIUM GRADE

Cylinder Cover

W.C. Vaughan Co. Collection

For Use with Rim and Mortise Cylinders.
Available in 1 7/8 inch Diameters for Doors.
Regularly Furnished with Compression Springs and No. 4 x 5/8" FHWS.
Solid Turned Brass Escutcheon and Cover.
Standard, Custom Plated and Patinated Finishes Available.

Full Scale

E. R. BUTLER & CO.

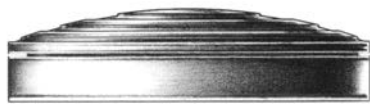
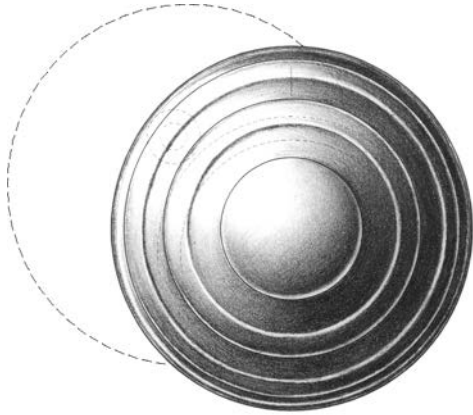

fig. fr

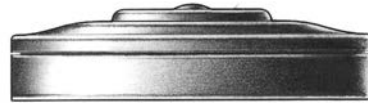
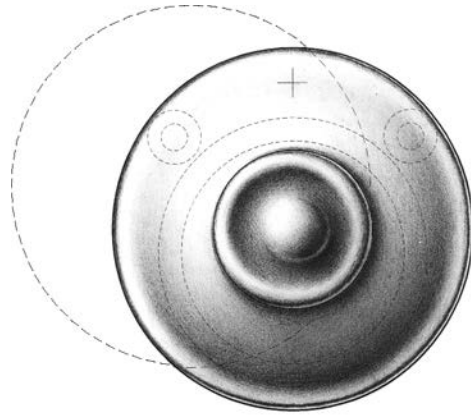

fig. by

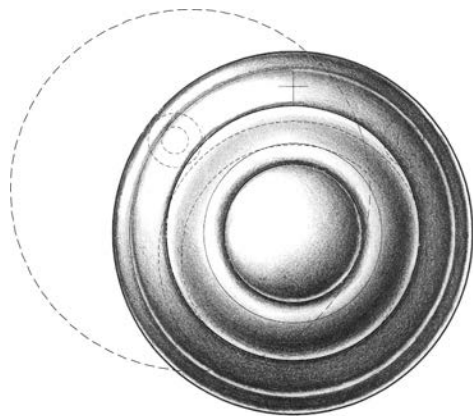

fig. do

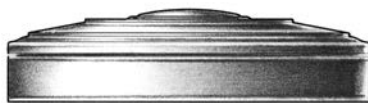
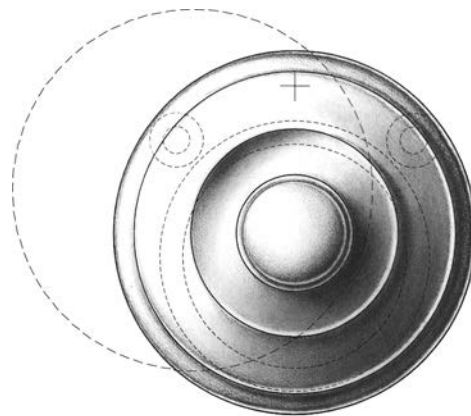

fig. kb

PREMIUM GRADE

Cylinder Cover

W.C. Vaughan Co. Collection

For Use with Rim and Mortise Cylinders.
Available in 1 7/8 inch Diameters for Doors.
Regularly Furnished with Compression Springs and No. 4 x 5/8" FHWS.
Solid Turned Brass Escutcheon and Cover.
Standard, Custom Plated and Patinated Finishes Available.

Full Scale

FINE ARCHITECTURAL, BUILDERS' AND CABINETMAKERS' HARDWARE

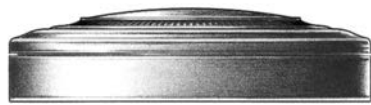
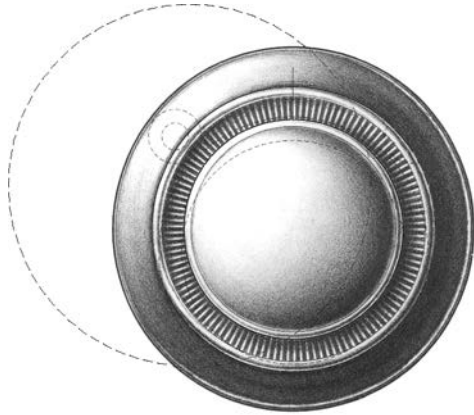

fig. ky

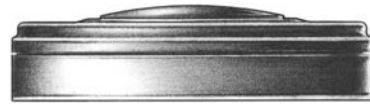
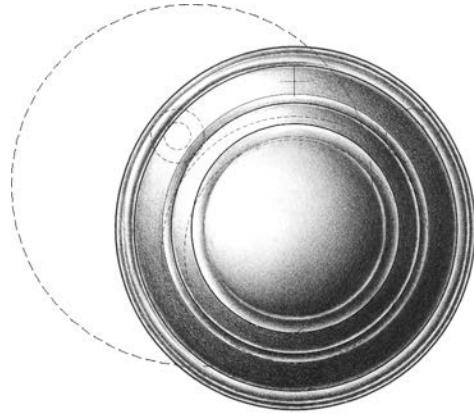

fig. lk

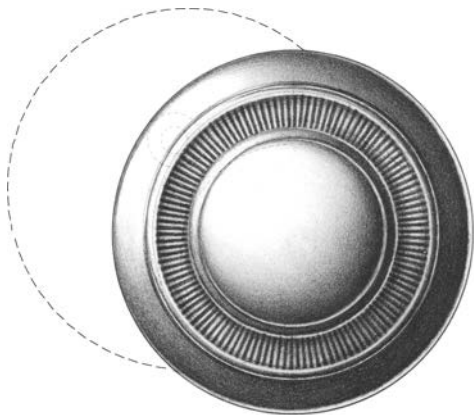

fig. dk

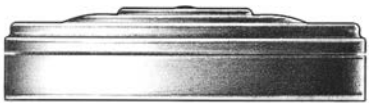
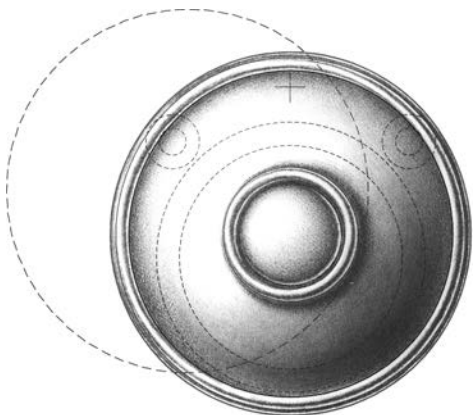

fig. rb

PREMIUM GRADE

Cylinder Cover

W.C. Vaughan Co. Collection

For Use with Rim and Mortise Cylinders.
Available in 1 7/8 inch Diameters for Doors.
Regularly Furnished with Compression Springs and No. 4 x 5/8" FHWS.
Solid Turned Brass Escutcheon and Cover.
Standard, Custom Plated and Patinated Finishes Available.

Full Scale

FINE ARCHITECTURAL, BUILDERS' AND CABINETMAKERS' HARDWARE

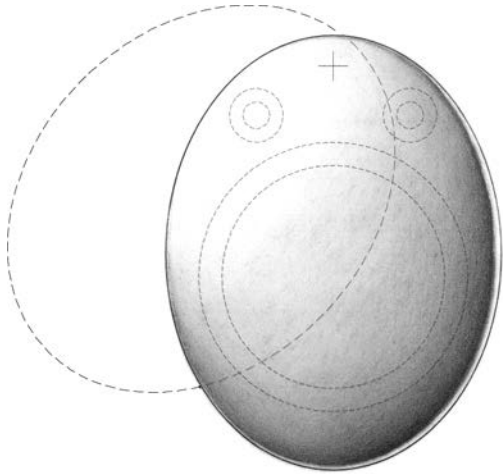

fig. ov

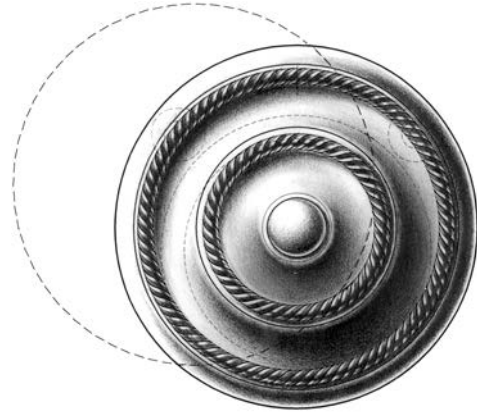

fig. kr

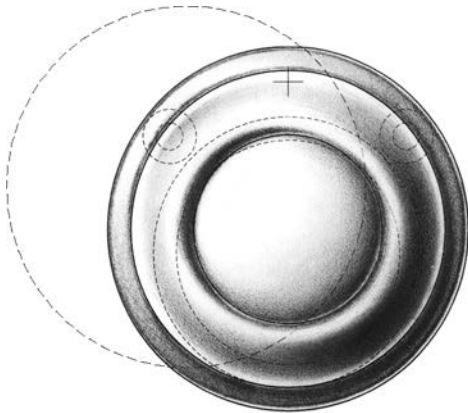

fig. eg

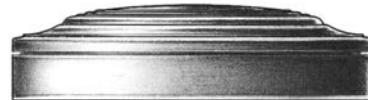
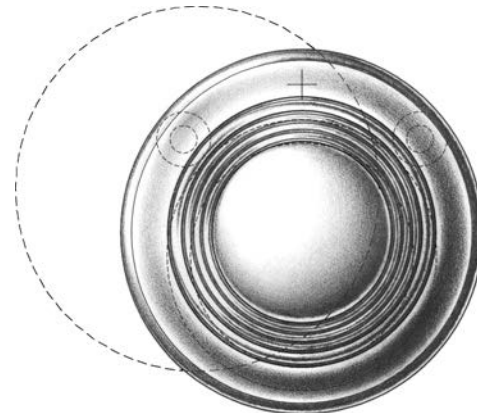

fig. og

PREMIUM GRADE

Cylinder Cover

W.C. Vaughan Co. Collection

For Use with Rim and Mortise Cylinders.
Available in 1 7/8 inch Diameters for Doors.
Regularly Furnished with Compression Springs and No. 4 x 5/8" FHWS.
Solid Turned Brass Escutcheon and Cover.
Standard, Custom Plated and Patinated Finishes Available.

Full Scale

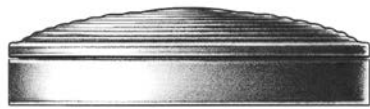
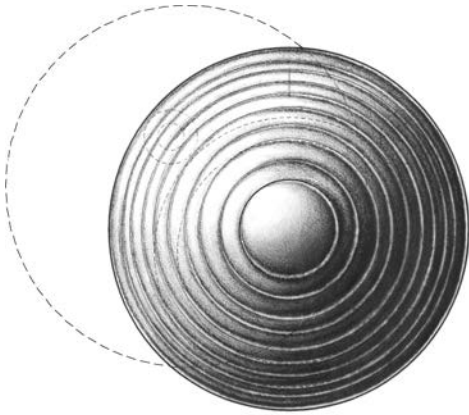

fig. en

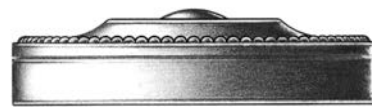
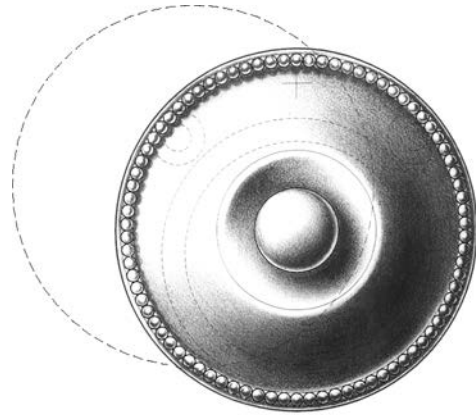

fig. bf

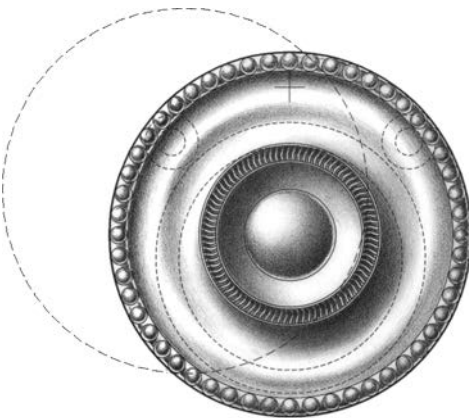

fig. vf

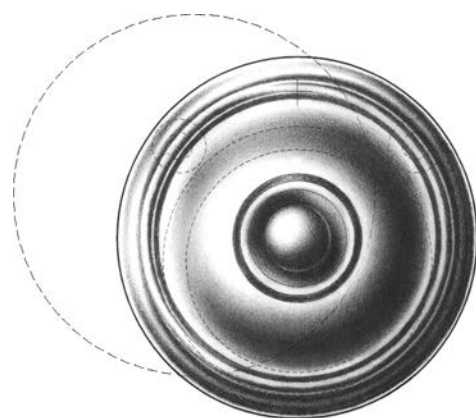

fig. va

PREMIUM GRADE

Cylinder Cover

W.C. Vaughan Co. Collection

For Use with Rim and Mortise Cylinders.
Available in 1 7/8 inch Diameters for Doors.
Regularly Furnished with Compression Springs and No. 4 x 5/8" FHWS.
Solid Turned Brass Escutcheon and Cover.
Standard, Custom Plated and Patinated Finishes Available.

Full Scale

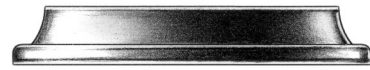

fig. er

fig. ng

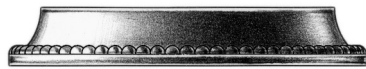

fig. nb

fig. nk

BUILDERS' GRADE

Compression-Type Cylinder Ring

W.C. Vaughan Co. Collection

For Use with Rim and Mortise Cylinders.
Regularly Furnished with Compression Springs.
Machined Solid Brass.
Standard, Custom Plated and Patinated Finishes Available.

Full Scale

E.R. BUTLER & CO.

THUMB TURNS

© E.R. BUTLER & CO. ALL RIGHTS RESERVED.

FINE ARCHITECTURAL, BUILDERS' AND CABINETMAKERS' HARDWARE

E. R. BUTLER & CO.

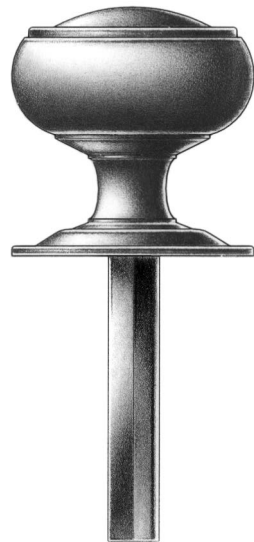
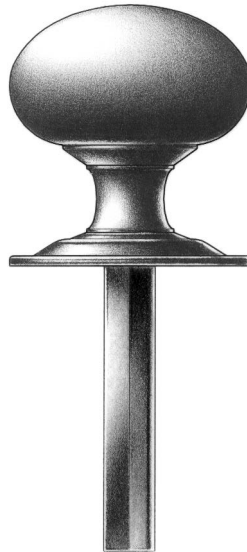
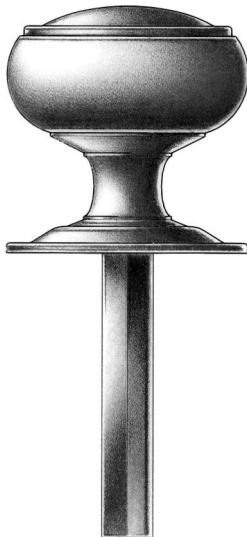
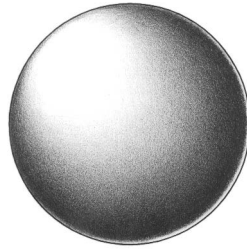

fig. ng

fig. vc

fig. nn

PREMIUM GRADE

Traditional Thumb Turns and Roses

W.C. Vaughan Co. Collection

Available in 1 ¼ inch Diameters for Privacy and Patio Doors.
Standard with 3/16 inch Spindle on the Diagonal.
Regularly Furnished with Two No. 4 × ½" OHWS.
Solid Turned Brass Knob and Rose.
Standard, Custom Plated and Patinated Finishes Available.

Full Scale

FINE ARCHITECTURAL, BUILDERS' AND CABINETMAKERS' HARDWARE

E. R. BUTLER & CO.

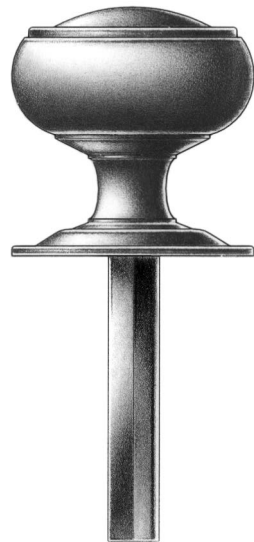
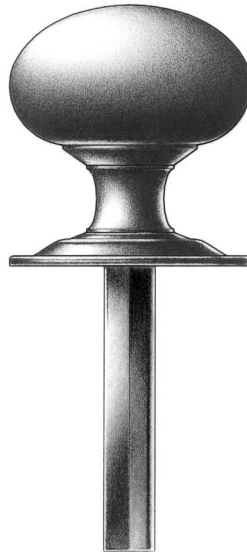
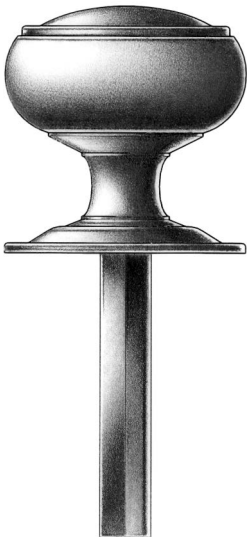

fig. ng

fig. vc

fig. nn

PREMIUM GRADE

Traditional Thumb Turns and Roses
W.C. Vaughan Co. Collection

Available in 1 1/4 inch Diameters for Privacy and Patio Doors.
Standard with 3/16 inch Spindle on the Diagonal.
Regularly Furnished with Two No. 4 x 1/2" OHWS.
Solid Turned Brass Knob and Rose.
Standard, Custom Plated and Patinated Finishes Available.

Full Scale

FINE ARCHITECTURAL, BUILDERS' AND CABINETMAKERS' HARDWARE

E. R. BUTLER & CO.

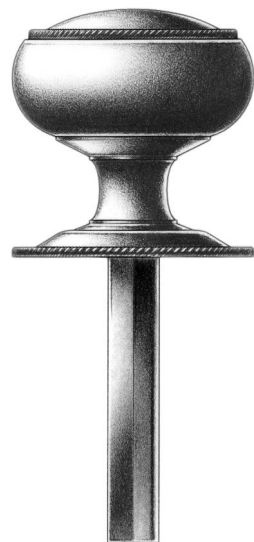
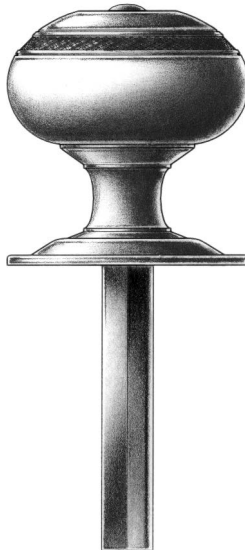
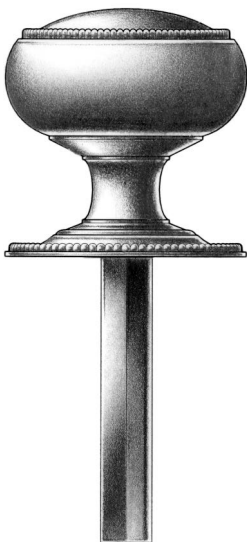

fig. nb

fig. kb

fig. nk

PREMIUM GRADE

Traditional Thumb Turns and Roses

W.C. Vaughan Co. Collection

Available in 1 ¼ inch Diameters for Privacy and Patio Doors.
Standard with ⅜ inch Spindle on the Diagonal.
Regularly Furnished with Two No. 4 × ½" OHWS.
Solid Turned Brass Knob and Rose.
Standard, Custom Plated and Patinated Finishes Available.

Full Scale

FINE ARCHITECTURAL, BUILDERS' AND CABINETMAKERS' HARDWARE

E. R. BUTLER & CO.

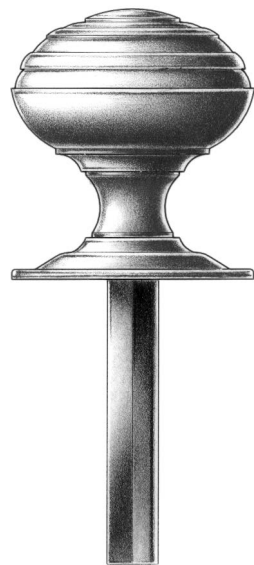
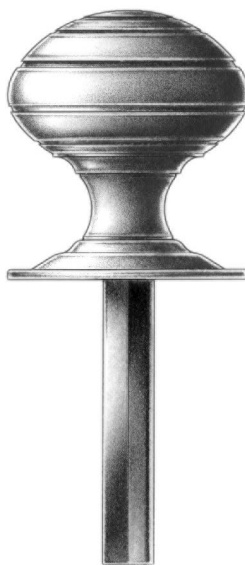
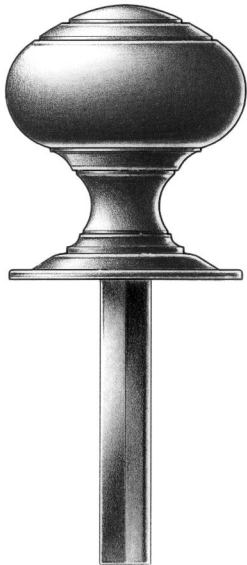
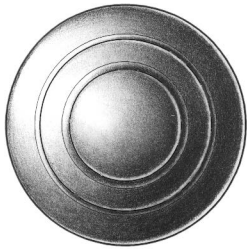

fig. lo

fig. sm

fig. fr

PREMIUM GRADE

Traditional Thumb Turns and Roses

W.C. Vaughan Co. Collection

Available in 1 ¼ inch Diameters for Privacy and Patio Doors.

Standard with ⅜ inch Spindle on the Diagonal.

Regularly Furnished with Two No. 4 × ½" OHWS.

Solid Turned Brass Knob and Rose.

Standard, Custom Plated and Patinated Finishes Available.

Full Scale

FINE ARCHITECTURAL, BUILDERS' AND CABINETMAKERS' HARDWARE

E. R. BUTLER & CO.

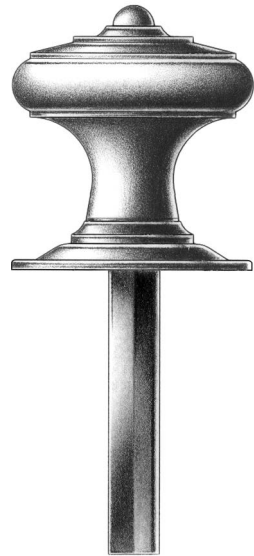
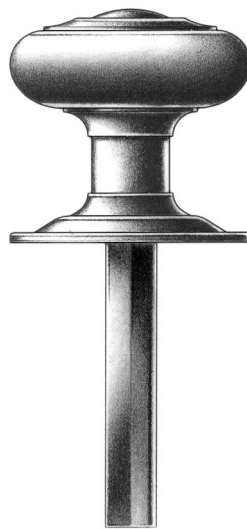
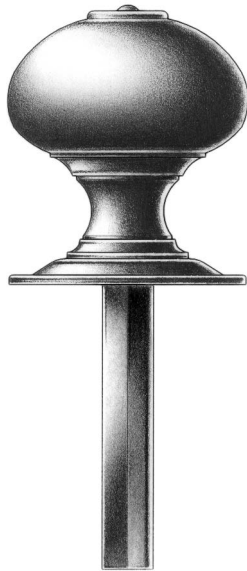
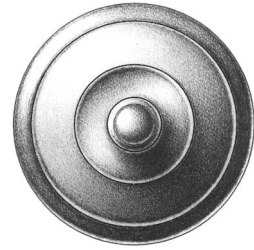
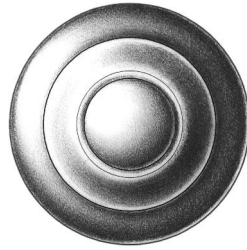
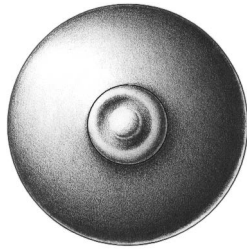

fig. by

fig. do

fig. kb

PREMIUM GRADE

Traditional Thumb Turns and Roses

W.C. Vaughan Co. Collection

Available in 1 1/4 inch Diameters for Privacy and Patio Doors.
Standard with 3/16 inch Spindle on the Diagonal.
Regularly Furnished with Two No. 4 x 1/2" OHWS.
Solid Turned Brass Knob and Rose.
Standard, Custom Plated and Patinated Finishes Available.

Full Scale

FINE ARCHITECTURAL, BUILDERS' AND CABINETMAKERS' HARDWARE

E. R. BUTLER & CO.

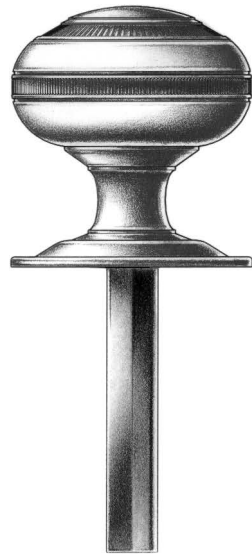
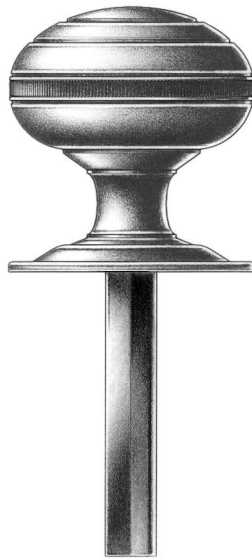
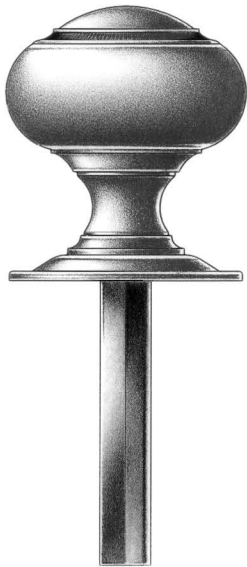
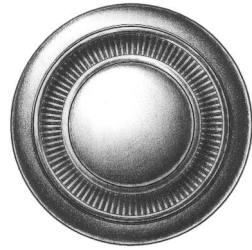
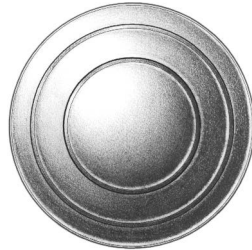
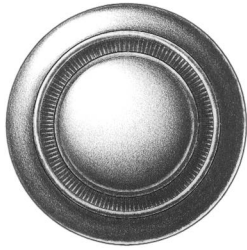

fig. ky

fig. lk

fig. dk

PREMIUM GRADE

Traditional Thumb Turns and Roses
W.C. Vaughan Co. Collection

Available in 1 1/4 inch Diameters for Privacy and Patio Doors.
Standard with 3/16 inch Spindle on the Diagonal.
Regularly Furnished with Two No. 4 x 1/2" OHWS.
Solid Turned Brass Knob and Rose.
Standard, Custom Plated and Patinated Finishes Available.

Full Scale

FINE ARCHITECTURAL, BUILDERS' AND CABINETMAKERS' HARDWARE

E. R. BUTLER & CO.

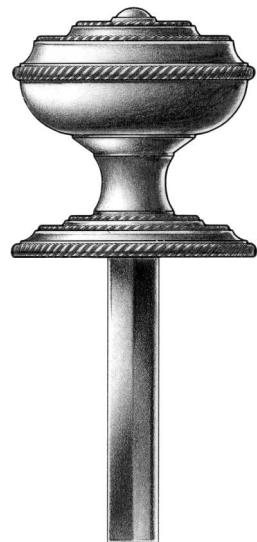
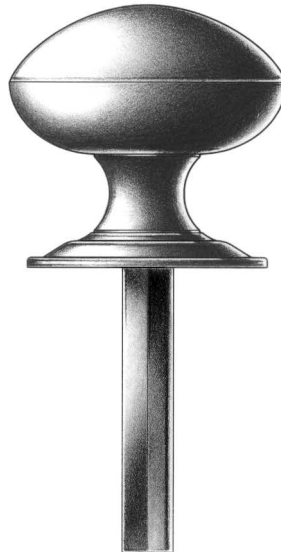
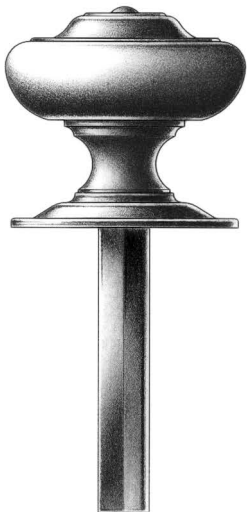
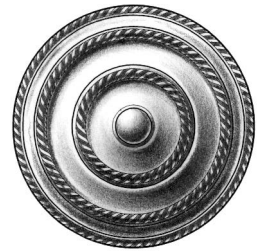
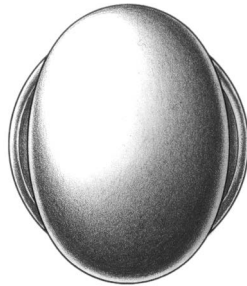
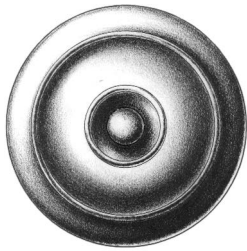

fig. rb

fig. ov

fig. kr

PREMIUM GRADE

Traditional Thumb Turns and Roses

W.C. Vaughan Co. Collection

Available in 1 ¼ inch Diameters for Privacy and Patio Doors.

Standard with 3/16 inch Spindle on the Diagonal.

Regularly Furnished with Two No. 4 × ½" OHWS.

Solid Turned Brass Knob and Rose.

Standard, Custom Plated and Patinated Finishes Available.

Full Scale

FINE ARCHITECTURAL, BUILDERS' AND CABINETMAKERS' HARDWARE

E. R. BUTLER & CO.

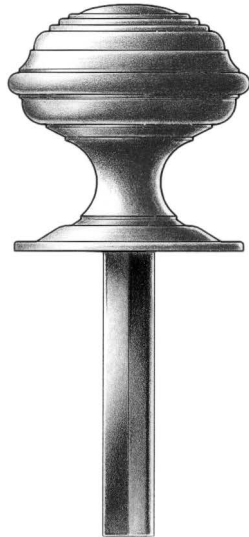
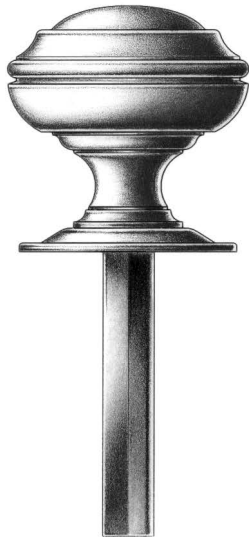
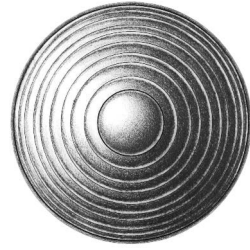
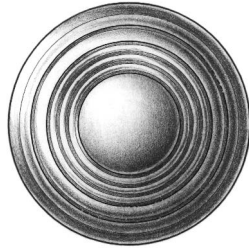
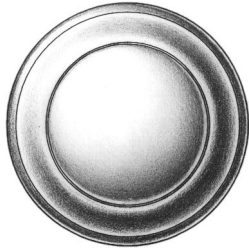

fig. eg

fig. og

fig. en

PREMIUM GRADE

Traditional Thumb Turns and Roses

W.C. Vaughan Co. Collection

Available in 1 ¼ inch Diameters for Privacy and Patio Doors.
Standard with 3/16 inch Spindle on the Diagonal.
Regularly Furnished with Two No. 4 × ½" OHWS.
Solid Turned Brass Knob and Rose.
Standard, Custom Plated and Patinated Finishes Available.

Full Scale

FINE ARCHITECTURAL, BUILDERS' AND CABINETMAKERS' HARDWARE

E. R. BUTLER & CO.

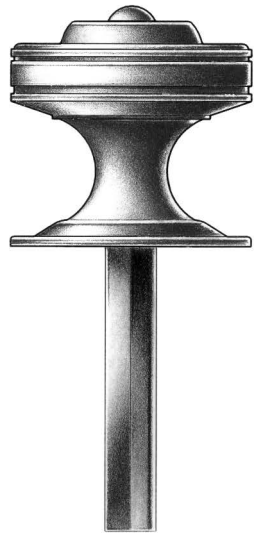
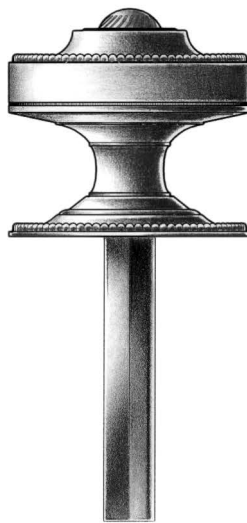
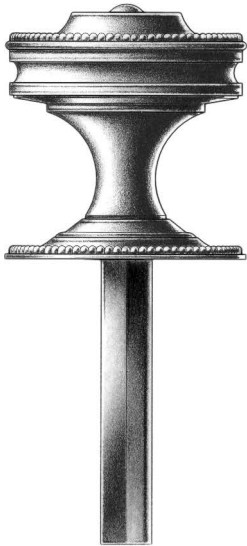
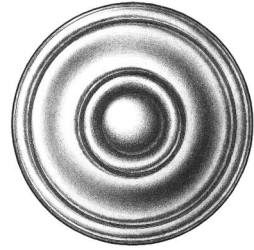
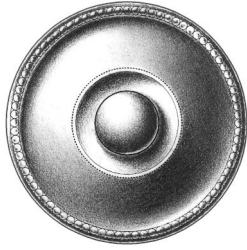

fig. bf

fig. vf

fig. va

PREMIUM GRADE

Traditional Thumb Turns and Roses

W.C. Vaughan Co. Collection

Available in 1 1/4 inch Diameters for Privacy and Patio Doors.
Standard with 3/16 inch Spindle on the Diagonal.
Regularly Furnished with Two No. 4 x 1/2" OHWS.
Solid Turned Brass Knob and Rose.
Standard, Custom Plated and Patinated Finishes Available.

Full Scale

FINE ARCHITECTURAL, BUILDERS' AND CABINETMAKERS' HARDWARE

E. R. BUTLER & CO.

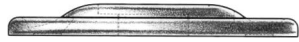

ridged



beaded



knurled



oval ridged

PREMIUM GRADE

Thumb Turn Rose Escutcheons
W.C. Vaughan Co. Collection

For Use with W.C. Vaughan Thumb Turns.
Solid Brass.
Standard, Custom Plated and Patinated Finishes Available.

Full Scale

FINE ARCHITECTURAL, BUILDERS' AND CABINETMAKERS' HARDWARE

E. R. BUTLER & CO.

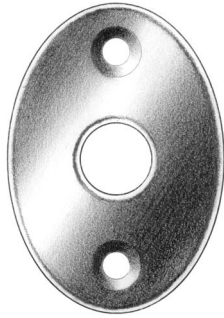

oval

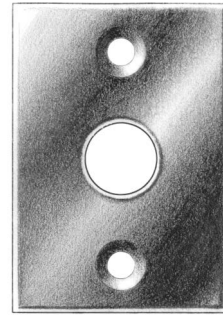

rectangular

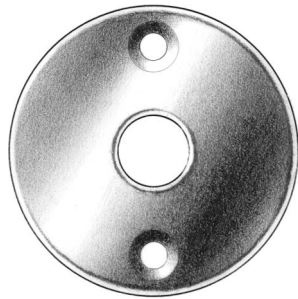

large round

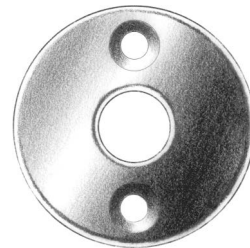

small round

PREMIUM GRADE

Thumb Turn Rose Escutcheons

W.C. Vaughan Co. Collection

For Use with W.C. Vaughan Thumb Turns.
Solid Brass.
Standard, Custom Plated and Patinated Finishes Available.

Full Scale

FINE ARCHITECTURAL, BUILDERS' AND CABINETMAKERS' HARDWARE

E. R. BUTLER & CO.

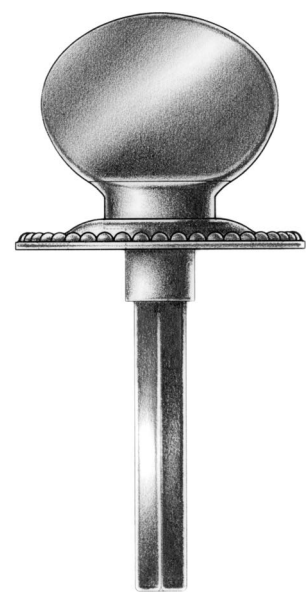
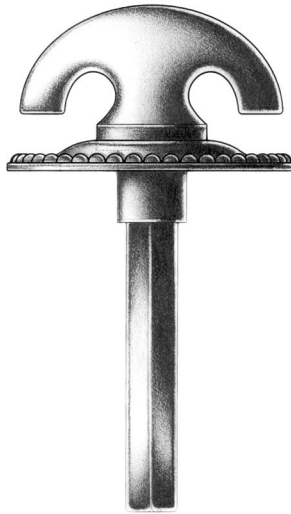
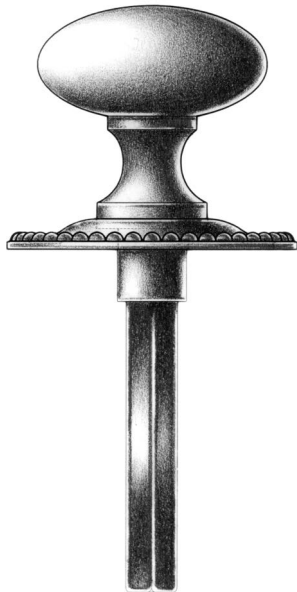
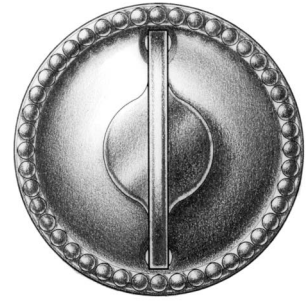
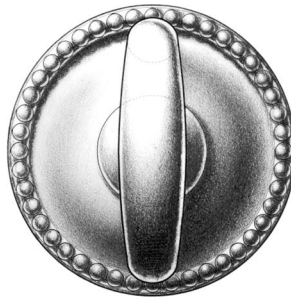
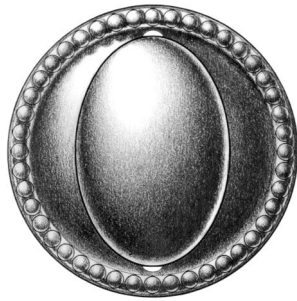

fig. oval

fig. crescent

fig. bow

PREMIUM GRADE

Traditional Thumb Turns with Beaded Roses

W.C. Vaughan Co. Collection

For Use on Privacy and Patio Doors.
Standard with $\frac{3}{16}$ inch Spindle on the Diagonal.
Regularly Furnished with Two No. 4 $\times \frac{1}{2}$ " OHWS.
Solid Cast Brass Knob and Rose.
Standard, Custom Plated and Patinated Finishes Available.

Full Scale

FINE ARCHITECTURAL, BUILDERS' AND CABINETMAKERS' HARDWARE

E. R. BUTLER & CO.

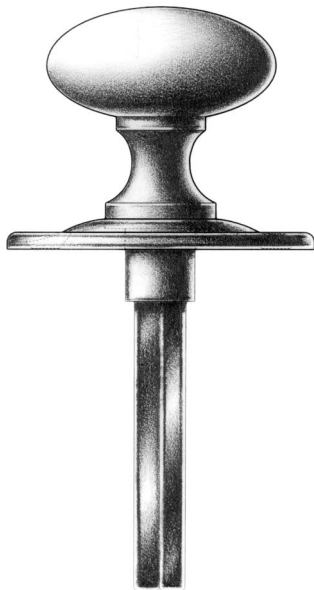
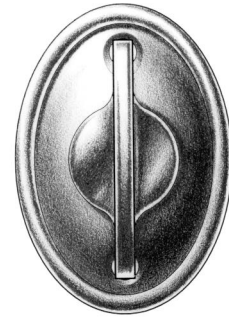
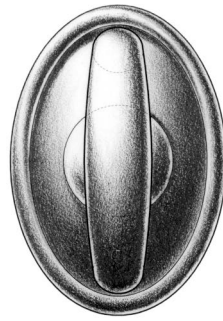

fig. oval

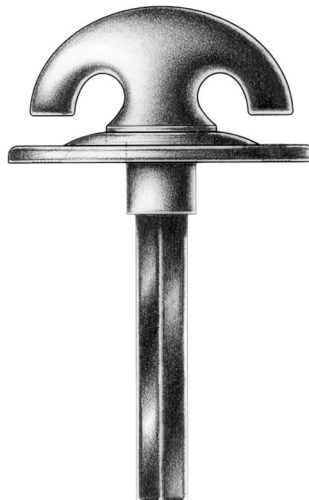

fig. crescent

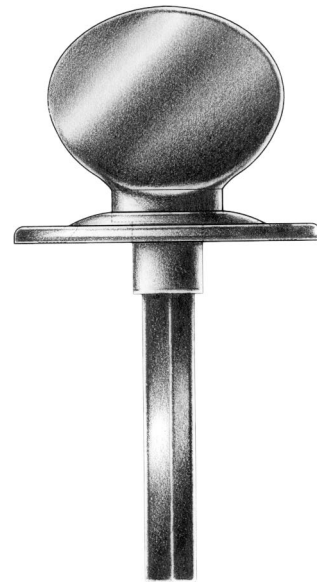

fig. bow

PREMIUM GRADE

Traditional Thumb Turns with Ridged Oval Roses

W.C. Vaughan Co. Collection

For Use on Privacy and Patio Doors.
Standard with $\frac{3}{16}$ inch Spindle on the Diagonal.
Regularly Furnished with Two No. 4 \times $\frac{1}{2}$ " OHWS.
Solid Cast Brass Knob and Rose.
Standard, Custom Plated and Patinated Finishes Available.

Full Scale

FINE ARCHITECTURAL, BUILDERS' AND CABINETMAKERS' HARDWARE

E. R. BUTLER & CO.

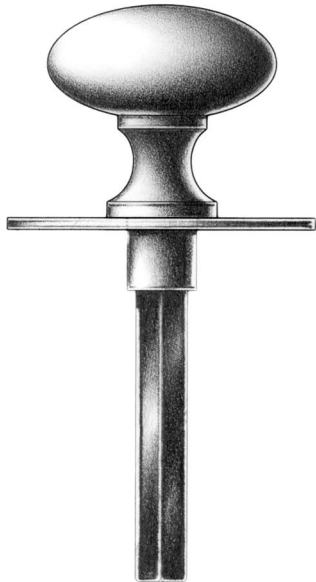
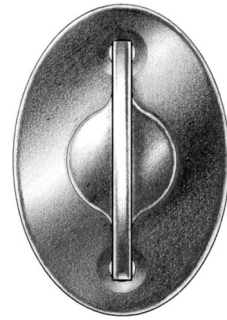
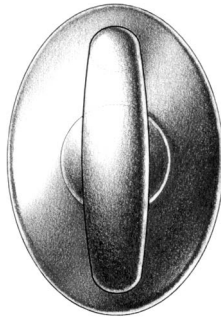
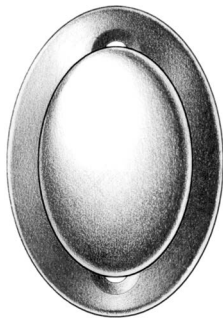

fig. oval

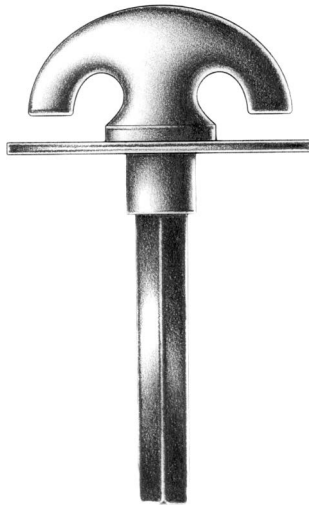

fig. crescent

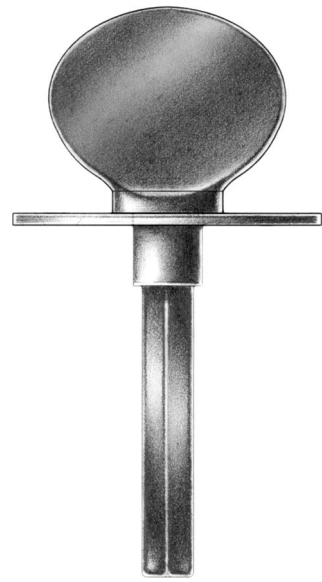

fig. bow

PREMIUM GRADE

Traditional Thumb Turns with Oval Escutcheons
W.C. Vaughan Co. Collection

For Use on Privacy and Patio Doors.
Standard with $\frac{3}{16}$ inch Spindle on the Diagonal.
Regularly Furnished with Two No. 4 $\times \frac{1}{2}$ " OHWS.
Solid Cast Brass Knob and Rose.
Standard, Custom Plated and Patinated Finishes Available.

Full Scale

FINE ARCHITECTURAL, BUILDERS' AND CABINETMAKERS' HARDWARE

E. R. BUTLER & CO.

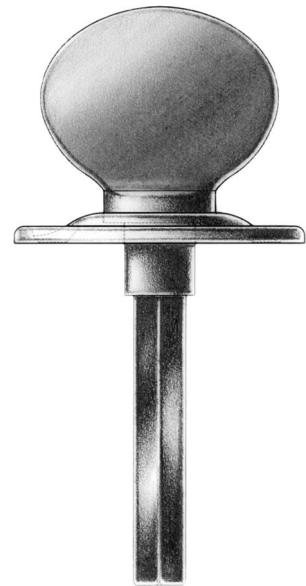
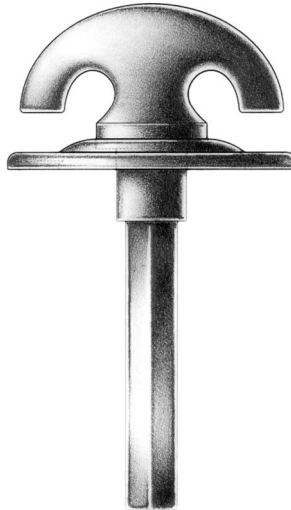
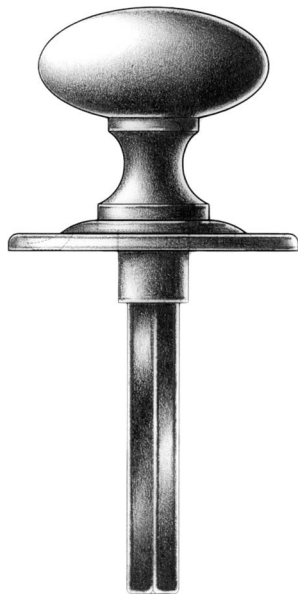
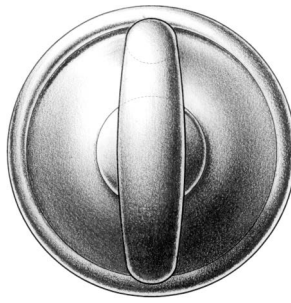

fig. oval

fig. crescent

fig. bow

PREMIUM GRADE

Traditional Thumb Turns with Ridged Roses

W.C. Vaughan Co. Collection

For Use on Privacy and Patio Doors.
Standard with $\frac{3}{16}$ inch Spindle on the Diagonal.
Regularly Furnished with Two No. 4 $\times \frac{1}{2}$ " OHWS.
Solid Cast Brass Knob and Rose.
Standard, Custom Plated and Patinated Finishes Available.

Full Scale

FINE ARCHITECTURAL, BUILDERS' AND CABINETMAKERS' HARDWARE

E. R. BUTLER & CO.

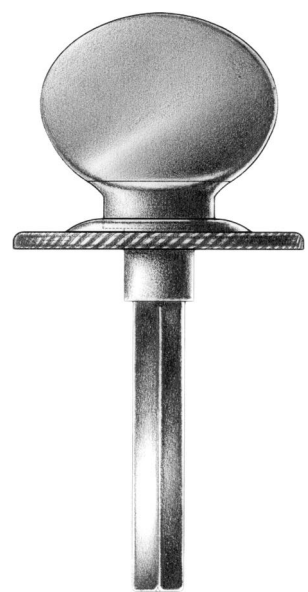
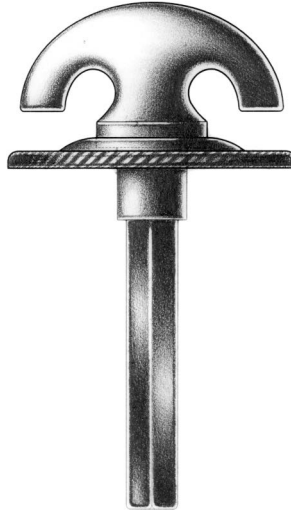
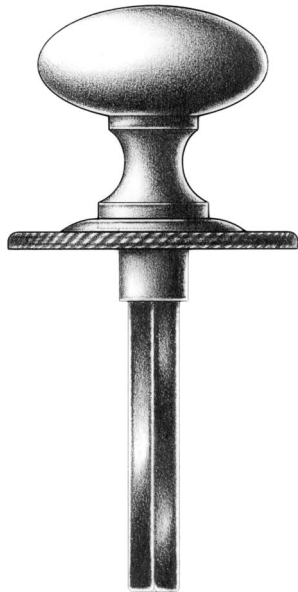
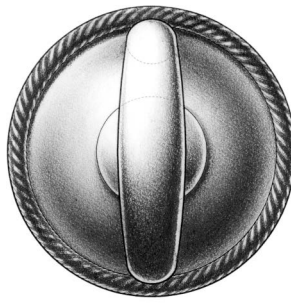

fig. oval

fig. crescent

fig. bow

PREMIUM GRADE

Traditional Thumb Turns with Knurled Roses

W.C. Vaughan Co. Collection

For Use on Privacy and Patio Doors.
Standard with $\frac{3}{16}$ inch Spindle on the Diagonal.
Regularly Furnished with Two No. 4 \times $\frac{1}{2}$ " OHWS.
Solid Cast Brass Knob and Rose.
Standard, Custom Plated and Patinated Finishes Available.

Full Scale

FINE ARCHITECTURAL, BUILDERS' AND CABINETMAKERS' HARDWARE

E. R. BUTLER & CO.

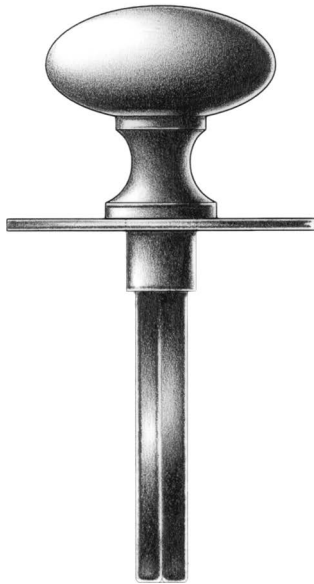
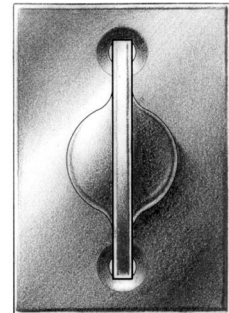
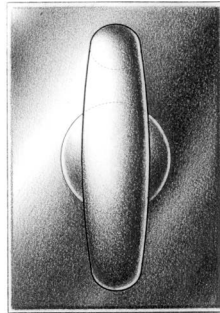
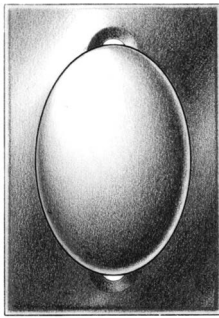

fig. oval

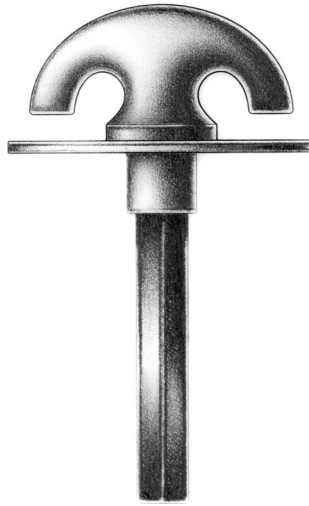

fig. crescent



fig. bow

PREMIUM GRADE

Traditional Thumb Turns with Rectangular Escutcheons
W.C. Vaughan Co. Collection

For Use on Privacy and Patio Doors.
Standard with $\frac{3}{16}$ inch Spindle on the Diagonal.
Regularly Furnished with Two No. 4 $\times \frac{1}{2}$ " OHWS.
Solid Cast Brass Knob and Rose.
Standard, Custom Plated and Patinated Finishes Available.

Full Scale

FINE ARCHITECTURAL, BUILDERS' AND CABINETMAKERS' HARDWARE

E.R. BUTLER & CO.

KEY ESCUTCHEONS

© E.R. BUTLER & CO. ALL RIGHTS RESERVED.

FINE ARCHITECTURAL, BUILDERS' AND CABINETMAKERS' HARDWARE

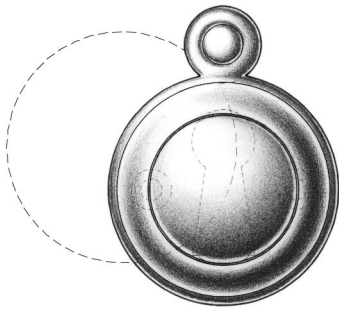

fig. eg

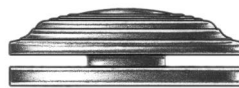
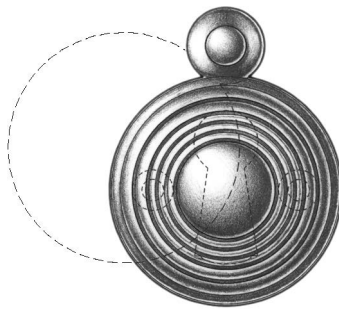

fig. og

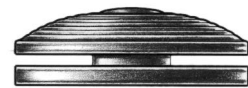
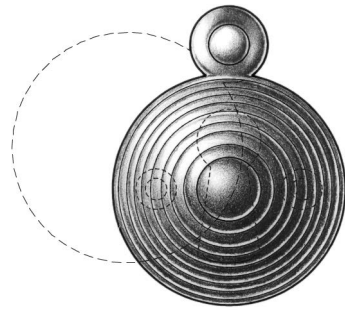

fig. en

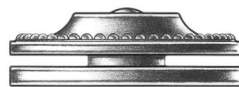
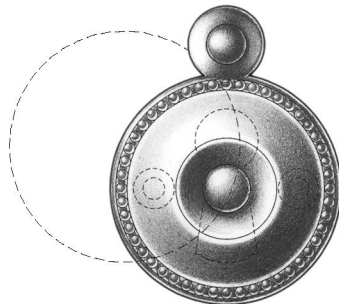

fig. bf

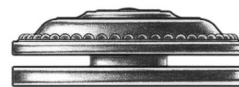
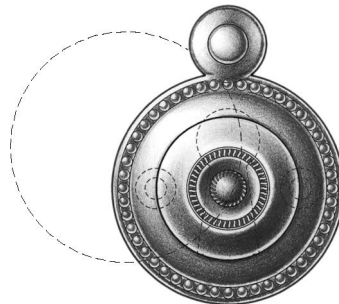

fig. vf

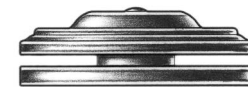
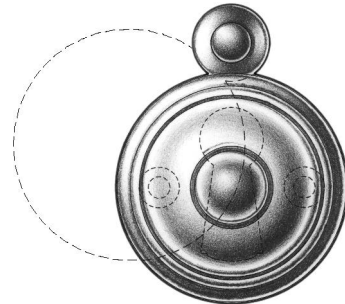

fig. va

PREMIUM GRADE

Traditional Drop Escutcheons

W.C. Vaughan Co. Collection

For Use as Emergency Release Covers.
Available in $1\frac{3}{16}$ inch Diameters for Doors.
Regularly Furnished with Two No. 3 \times $\frac{1}{2}$ " FHWS.
Solid Brass Turned Backplate and Swinging Cover.
Standard, Custom Plated and Patinated Finishes Available.

Full Scale

FINE ARCHITECTURAL, BUILDERS' AND CABINETMAKERS' HARDWARE

E. R. BUTLER & CO.

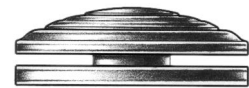
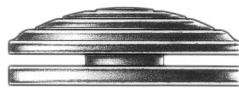
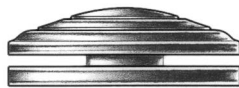
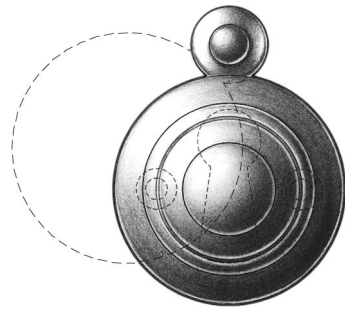
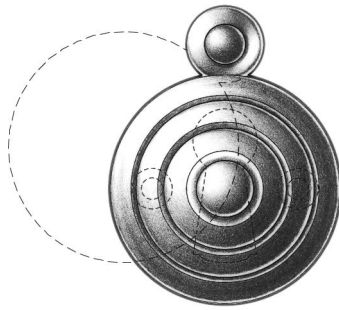
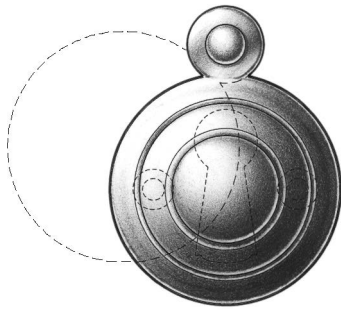

fig. lo

fig. sm

fig. fr

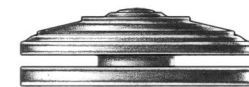
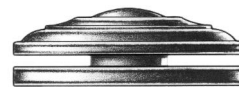
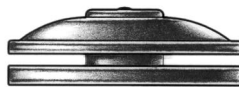
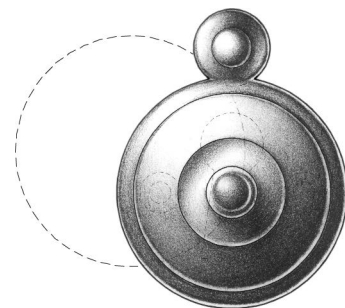
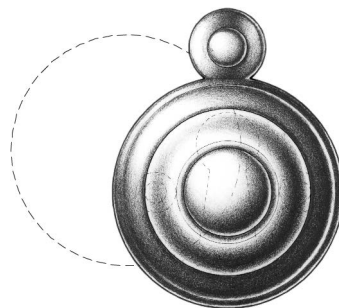
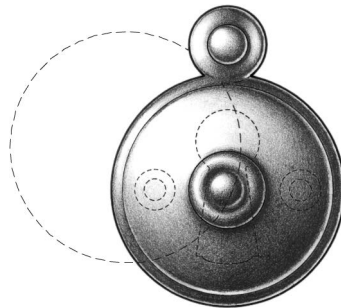

fig. by

fig. do

fig. kb

PREMIUM GRADE

Traditional Drop Escutcheons

W.C. Vaughan Co. Collection

For Use as Emergency Release Covers.
Available in 1³/₁₆ inch Diameters for Doors.
Regularly Furnished with Two No. 3 × 1/2" FHWS.
Solid Brass Turned Backplate and Swinging Cover.
Standard, Custom Plated and Patinated Finishes Available.

Full Scale

FINE ARCHITECTURAL, BUILDERS' AND CABINETMAKERS' HARDWARE

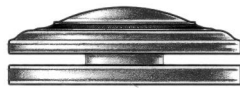
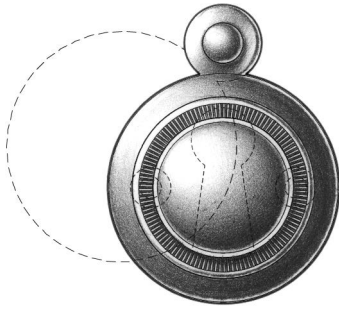

fig. ky

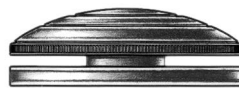
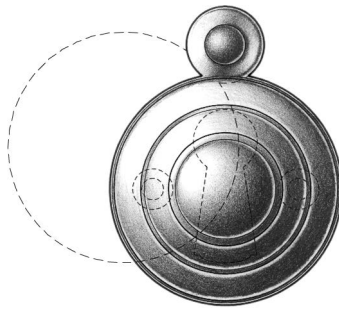

fig. lk

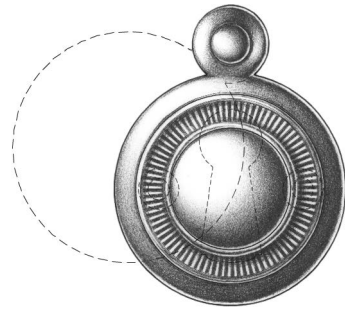

fig. dk

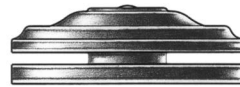
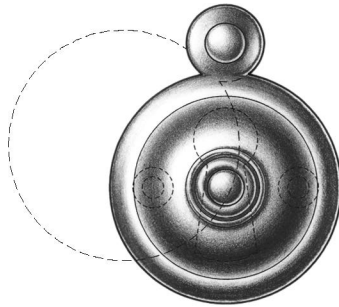

fig. rb

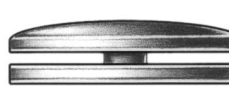
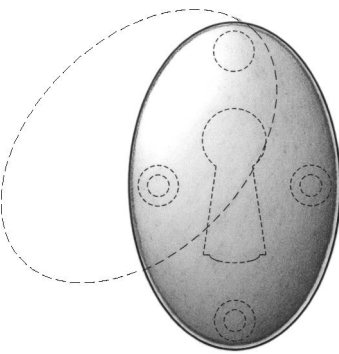

fig. ov

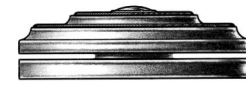
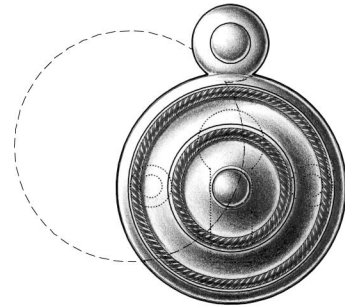

fig. kr

PREMIUM GRADE

Traditional Drop Escutcheons

W.C. Vaughan Co. Collection

For Use as Emergency Release Covers.
Available in $1\frac{3}{16}$ inch Diameters for Doors.
Regularly Furnished with Two No. 3 \times $\frac{1}{2}$ " FHWS.
Solid Brass Turned Backplate and Swinging Cover.
Standard, Custom Plated and Patinated Finishes Available.

Full Scale

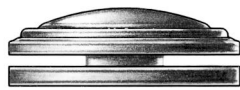
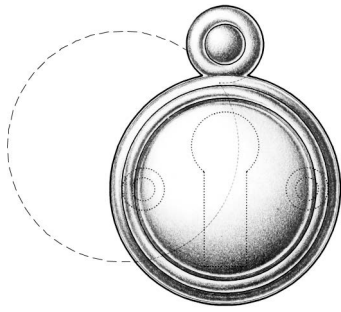

fig. ng

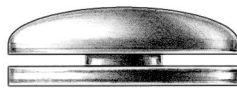
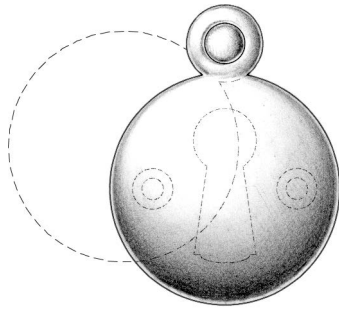

fig. vc

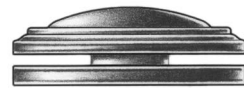
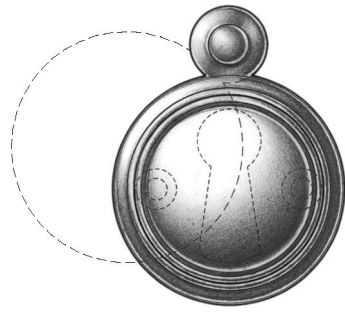

fig. nn

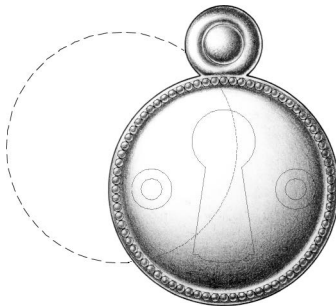

fig. nb

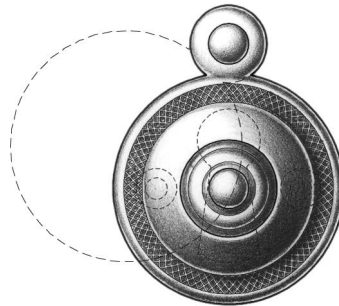

fig. kb

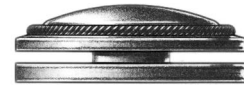
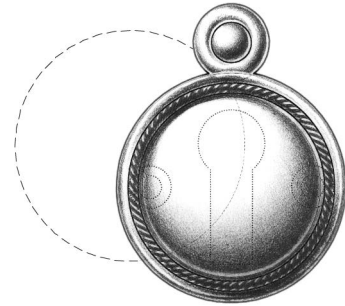

fig. nk

PREMIUM GRADE

Traditional Drop Escutcheons

W.C. Vaughan Co. Collection

For Use as Emergency Release Covers.
Available in 1³/₁₆ inch Diameters for Doors.
Regularly Furnished with Two No. 3 × 1/2" FHWS.
Solid Brass Turned Backplate and Swinging Cover.
Standard, Custom Plated and Patinated Finishes Available.

Full Scale

E. R. BUTLER & CO.

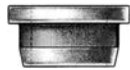

flat



ridged



beaded



knurled

PREMIUM GRADE

Emergency Release Grommets

W.C. Vaughan Co. Collection

For Use as Emergency Release Trim.
Available in $\frac{5}{8}$ inch Diameters for Doors.
Solid Turned Brass.
Standard, Custom Plated and Patinated Finishes Available.

Full Scale

FINE ARCHITECTURAL, BUILDERS' AND CABINETMAKERS' HARDWARE

E.R. BUTLER & CO.

HINGE FINIALS

© E.R. BUTLER & CO. ALL RIGHTS RESERVED.

FINE ARCHITECTURAL, BUILDERS' AND CABINETMAKERS' HARDWARE

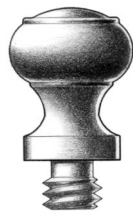

fig. ng

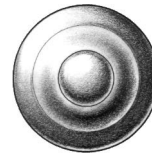
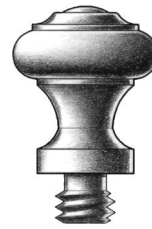

fig. do

PREMIUM GRADE

Traditional Hinge Finials

W.C. Vaughan Co. Collection

For Use with All E.R. Butler & Co. Full Mortise Template, Wide Throw, Paumelle and Interlock Hinges.

Available for $\frac{5}{16}$, $\frac{3}{8}$, $\frac{1}{2}$, $\frac{9}{16}$, and $\frac{5}{8}$ inch Barrel Diameters. ($\frac{1}{2}$ inch Shown.)

Solid Turned Brass.

Standard, Custom Plated and Patinated Finishes Available.

Full Scale

E.R. BUTLER & CO.

DOOR STOPS

© E.R. BUTLER & CO. ALL RIGHTS RESERVED.

FINE ARCHITECTURAL, BUILDERS' AND CABINETMAKERS' HARDWARE

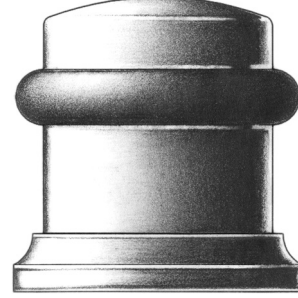
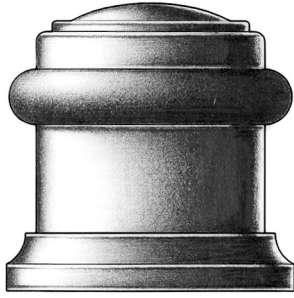
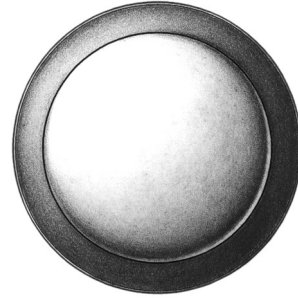

fig. ng

fig. vc

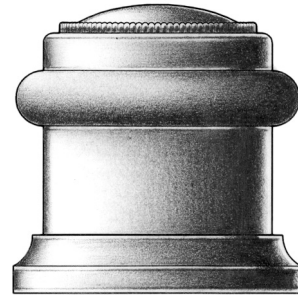
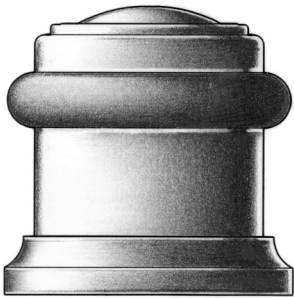

fig. mn

fig. nb

PREMIUM GRADE

Traditional Cylindrical Floor Stop

W.C. Vaughan Co. Collection

Available in 1 3/8 inch Diameters for Doors.
Available with Round or Square Bumper Ring (Round Bumper Shown).
Solid Turned Brass with Gray, Brown, or Black Rubber Bumper Ring.
Standard, Custom Plated and Patinated Finishes Available.

Full Scale

E. R. BUTLER & CO.

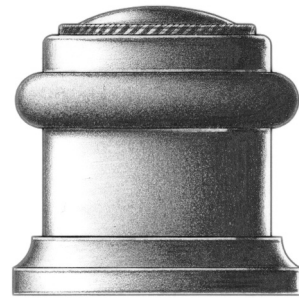
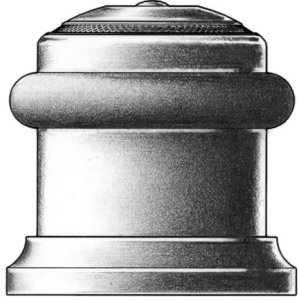

fig. kb

fig. nk

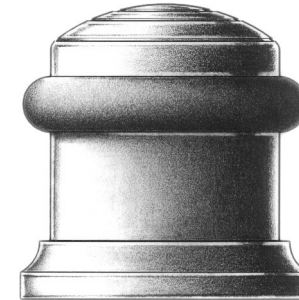
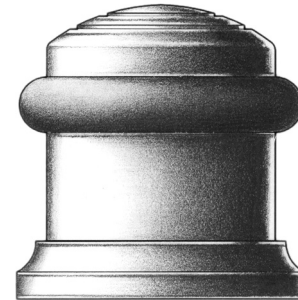

fig. lo

fig. sm

PREMIUM GRADE

Traditional Cylindrical Floor Stop

W.C. Vaughan Co. Collection

Available in 1 3/8 inch Diameters for Doors.
Available with Round or Square Bumper Ring (Round Bumper Shown).
Solid Turned Brass with Gray, Brown, or Black Rubber Bumper Ring.
Standard, Custom Plated and Patinated Finishes Available.

Full Scale

FINE ARCHITECTURAL, BUILDERS' AND CABINETMAKERS' HARDWARE

E. R. BUTLER & CO.

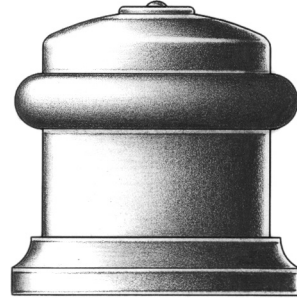
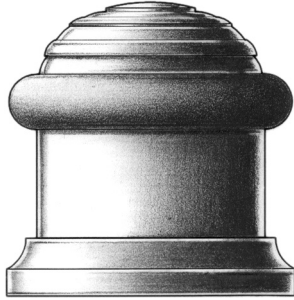

fig. fr

fig. by

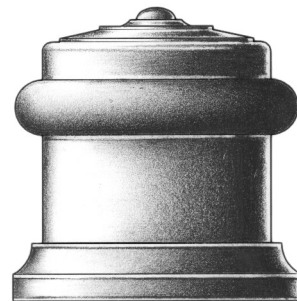
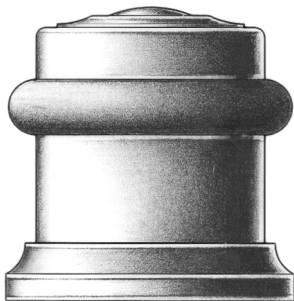
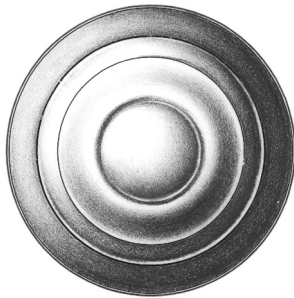

fig. do

fig. kb

PREMIUM GRADE

Traditional Cylindrical Floor Stop

W.C. Vaughan Co. Collection

Available in 1 3/8 inch Diameters for Doors.
Available with Round or Square Bumper Ring (Round Bumper Shown).
Solid Turned Brass with Gray, Brown, or Black Rubber Bumper Ring.
Standard, Custom Plated and Patinated Finishes Available.

Full Scale

FINE ARCHITECTURAL, BUILDERS' AND CABINETMAKERS' HARDWARE

E. R. BUTLER & CO.

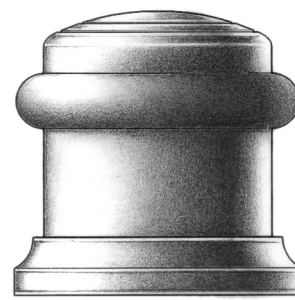
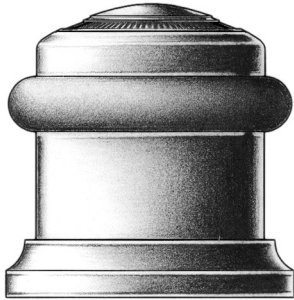
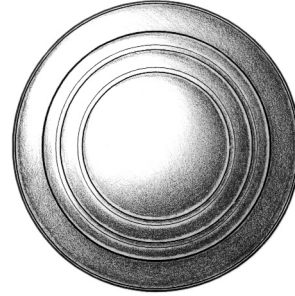

fig. ky

fig. lk

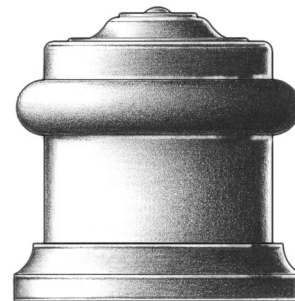
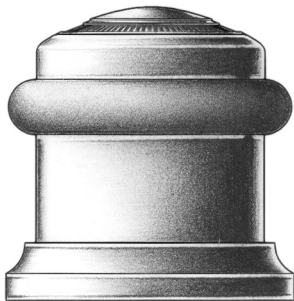
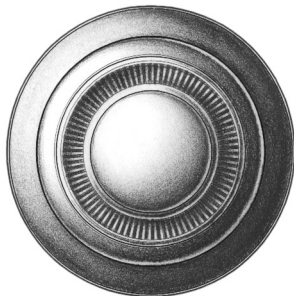

fig. dk

fig. rb

PREMIUM GRADE

Traditional Cylindrical Floor Stop

W.C. Vaughan Co. Collection

Available in 1 3/8 inch Diameters for Doors.
Available with Round or Square Bumper Ring (Round Bumper Shown).
Solid Turned Brass with Gray, Brown, or Black Rubber Bumper Ring.
Standard, Custom Plated and Patinated Finishes Available.

Full Scale

FINE ARCHITECTURAL, BUILDERS' AND CABINETMAKERS' HARDWARE

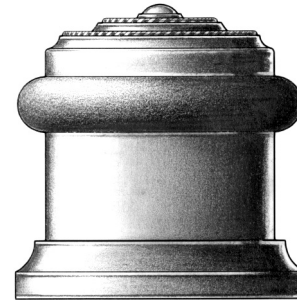
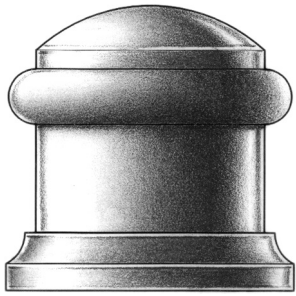
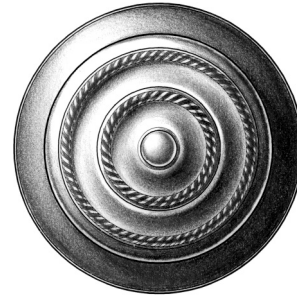
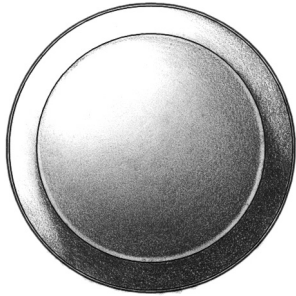

fig. ov

fig. lr

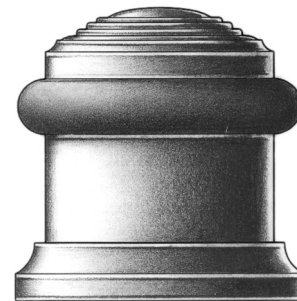
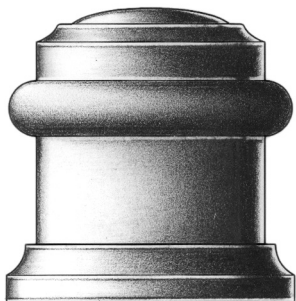

fig. eg

fig. og

PREMIUM GRADE

Traditional Cylindrical Floor Stop

W.C. Vaughan Co. Collection

Available in 1 3/8 inch Diameters for Doors.
Available with Round or Square Bumper Ring (Round Bumper Shown).
Solid Turned Brass with Gray, Brown, or Black Rubber Bumper Ring.
Standard, Custom Plated and Patinated Finishes Available.

Full Scale

E. R. BUTLER & CO.

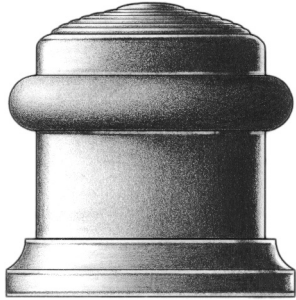

fig. en

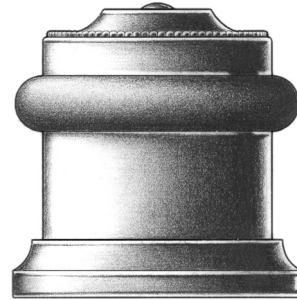

fig. bf

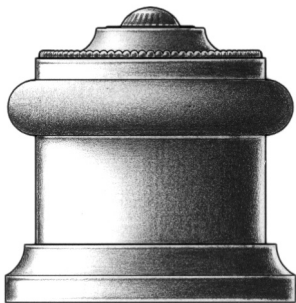

fig. vf

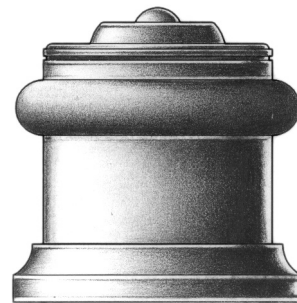

fig. va

PREMIUM GRADE

Traditional Cylindrical Floor Stop

W.C. Vaughan Co. Collection

Available in 1 3/8 inch Diameters for Doors.
Available with Round or Square Bumper Ring (Round Bumper Shown).
Solid Turned Brass with Gray, Brown, or Black Rubber Bumper Ring.
Standard, Custom Plated and Patinated Finishes Available.

Full Scale

FINE ARCHITECTURAL, BUILDERS' AND CABINETMAKERS' HARDWARE

E. R. BUTLER & CO.

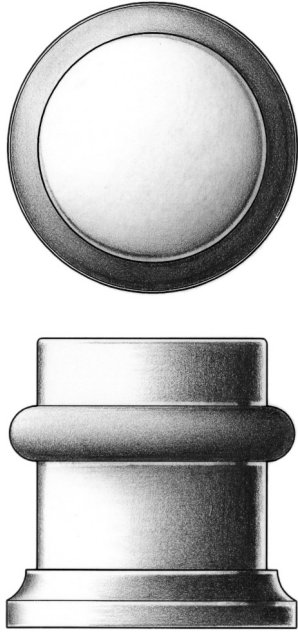

fig. ft

PREMIUM GRADE

Traditional Cylindrical Floor Stop

W.C. Vaughan Co. Collection

Available in 1 3/8 inch Diameters for Doors.
Available with Round or Square Bumper Ring (Round Bumper Shown).
Solid Turned Brass with Gray, Brown, or Black Rubber Bumper Ring.
Standard, Custom Plated and Patinated Finishes Available.

Full Scale

FINE ARCHITECTURAL, BUILDERS' AND CABINETMAKERS' HARDWARE

E. R. BUTLER & CO.

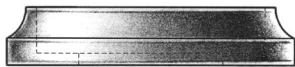
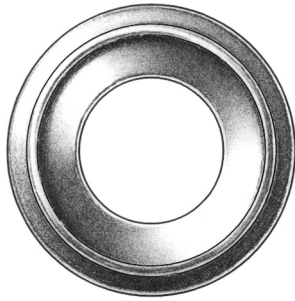

plain

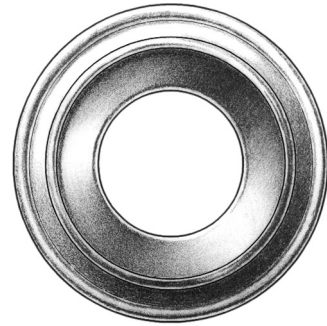

ridged

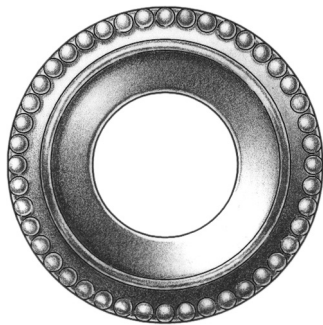

beaded

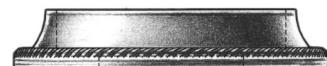

knurled

PREMIUM GRADE

Traditional Floor Stop Trim Rings

W.C. Vaughan Co. Collection

For Use with 1 3/8 inch Diameter Cylindrical W.C. Vaughan Floor Stops.

Solid Turned Brass.

Standard, Custom Plated and Patinated Finishes Available.

Full Scale

FINE ARCHITECTURAL, BUILDERS' AND CABINETMAKERS' HARDWARE

E. R. BUTLER & CO.

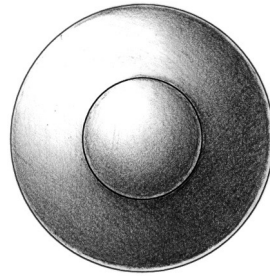

PREMIUM GRADE

Base Wall Stop
W.C. Vaughan Co. Collection

Available in $1\frac{3}{8} \times 2\frac{1}{2}$ inch Dimensions (Diameter \times Projection) for Doors.
Solid Turned Brass with Gray, Brown, or Black Rubber Bumper.
Standard, Custom Plated and Patinated Finishes Available.

Full Scale

FINE ARCHITECTURAL, BUILDERS' AND CABINETMAKERS' HARDWARE

E. R. BUTLER & CO.

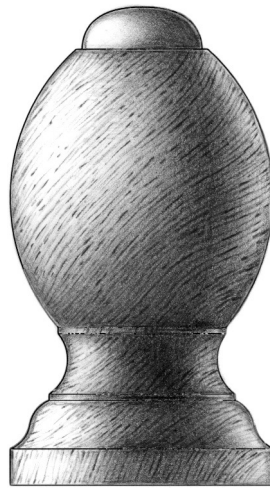
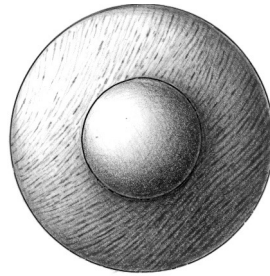

PREMIUM GRADE

Wood Base Wall Stop

W.C. Vaughan Co. Collection

Available in $1\frac{3}{8} \times 2\frac{1}{2}$ inch Dimensions (Diameter \times Projection) for Doors.
Solid White Birch with Gray, Brown, or Black Rubber Bumper.
Standard, Custom Plated and Patinated Finishes Available.

Full Scale

FINE ARCHITECTURAL, BUILDERS' AND CABINETMAKERS' HARDWARE

E.R. BUTLER & CO.

CABINET HARDWARE

© E.R. BUTLER & CO. ALL RIGHTS RESERVED.

FINE ARCHITECTURAL, BUILDERS' AND CABINETMAKERS' HARDWARE

E. R. BUTLER & CO.



fig. ng



fig. vc



fig. nm



fig. nb



fig. kb



fig. nk

PREMIUM GRADE

Vaughan Design Series Cabinet Knobs

W.C. Vaughan Company Collection

Available in 1 1/2, 1 1/4, 1, 3/4 and 1/2 inch Diameters for Cabinets and Fine Furniture.

Supplied Standard Without Rose. Please Specify When Ordering.

Regularly Furnished With No. 8—32 x 1" Slotted PHMS.

For Use as a Shutter Knob, May Be Furnished With a Hanger Bolt.

Solid Brass Turned Cabinet Knob and Rose.

Standard, Custom Plated and Patinated Finishes Available.

Full Scale

FINE ARCHITECTURAL, BUILDERS' AND CABINETMAKERS' HARDWARE

E. R. BUTLER & CO.



fig. lo

fig. sm

fig. fr



fig. by

fig. do

fig. kb

PREMIUM GRADE

Vaughan Design Series Cabinet Knobs

W.C. Vaughan Company Collection

Available in 1 1/2, 1 1/4, 1, 3/4 and 1/2 inch Diameters for Cabinets and Fine Furniture.

Supplied Standard Without Rose. Please Specify When Ordering.

Regularly Furnished With No. 8—32 x 1" Slotted PHMS.

For Use as a Shutter Knob, May Be Furnished With a Hanger Bolt.

Solid Brass Turned Cabinet Knob and Rose.

Standard, Custom Plated and Patinated Finishes Available.

Full Scale

FINE ARCHITECTURAL, BUILDERS' AND CABINETMAKERS' HARDWARE



fig. ky



fig. lk



fig. dk



fig. rb



fig. ov



fig. kr



PREMIUM GRADE

Vaughan Design Series Cabinet Knobs

W.C. Vaughan Company Collection

Available in 1 1/2, 1 1/4, 1, 3/4 and 1/2 inch Diameters for Cabinets and Fine Furniture.

Supplied Standard Without Rose. Please Specify When Ordering.

Regularly Furnished With No. 8—32 x 1" Slotted PHMS.

For Use as a Shutter Knob, May Be Furnished With a Hanger Bolt.

Solid Brass Turned Cabinet Knob and Rose.

Standard, Custom Plated and Patinated Finishes Available.

Full Scale

E. R. BUTLER & CO.



fig. eg



fig. og



fig. en



fig. bf



fig. vf



fig. va

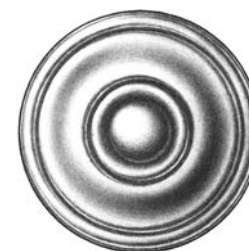

PREMIUM GRADE

Vaughan Design Series Cabinet Knobs

W.C. Vaughan Company Collection

Available in 1 1/2, 1 1/4, 1, 3/4 and 1/2 inch Diameters for Cabinets and Fine Furniture.

Supplied Standard Without Rose. Please Specify When Ordering.

Regularly Furnished With No. 8—32 x 1" Slotted PHMS.

For Use as a Shutter Knob, May Be Furnished With a Hanger Bolt.

Solid Brass Turned Cabinet Knob and Rose.

Standard, Custom Plated and Patinated Finishes Available.

Full Scale

FINE ARCHITECTURAL, BUILDERS' AND CABINETMAKERS' HARDWARE

E.R. BUTLER & CO.

SHUTTER HARDWARE

© E.R. BUTLER & CO. ALL RIGHTS RESERVED.

FINE ARCHITECTURAL, BUILDERS' AND CABINETMAKERS' HARDWARE

E. R. BUTLER & CO.

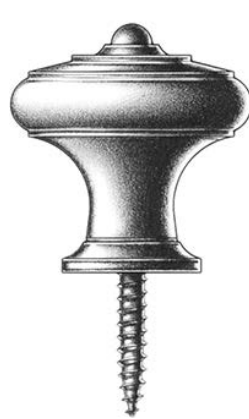

fig. by

fig. do

fig. kb

PREMIUM GRADE

Traditional Shutter Knobs
W.C. Vaughan Company Collection

Available in 1 1/4 inch Diameters for Surface Mounting.
Solid Turned Brass Knob.
Standard, Custom Plated and Patinated Finishes Available.

Full Scale

FINE ARCHITECTURAL, BUILDERS' AND CABINETMAKERS' HARDWARE

E. R. BUTLER & CO.



fig. ky

fig. lk

fig. dk

PREMIUM GRADE

Traditional Shutter Knobs
W.C. Vaughan Company Collection

Available in 1 1/4 inch Diameters for Surface Mounting.
Solid Turned Brass Knob.
Standard, Custom Plated and Patinated Finishes Available.

Full Scale

FINE ARCHITECTURAL, BUILDERS' AND CABINETMAKERS' HARDWARE

E. R. BUTLER & CO.

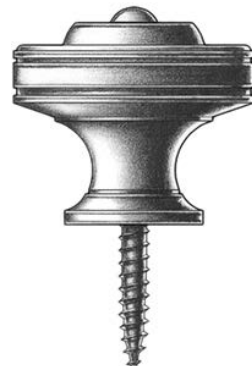
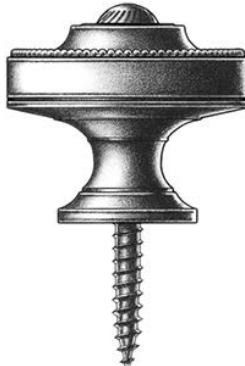
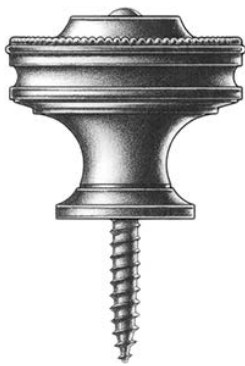

fig. bf

fig. vf

fig. va

PREMIUM GRADE

Traditional Shutter Knobs

W.C. Vaughan Company Collection

Available in 1 1/4 inch Diameters for Surface Mounting.
Solid Turned Brass Knob.
Standard, Custom Plated and Patinated Finishes Available.

Full Scale

FINE ARCHITECTURAL, BUILDERS' AND CABINETMAKERS' HARDWARE

E. R. BUTLER & CO.



fig. eg

fig. og

fig. en

PREMIUM GRADE

Traditional Shutter Knobs
W.C. Vaughan Company Collection

Available in 1 1/4 inch Diameters for Surface Mounting.
Solid Turned Brass Knob.
Standard, Custom Plated and Patinated Finishes Available.

Full Scale

FINE ARCHITECTURAL, BUILDERS' AND CABINETMAKERS' HARDWARE

E. R. BUTLER & CO.

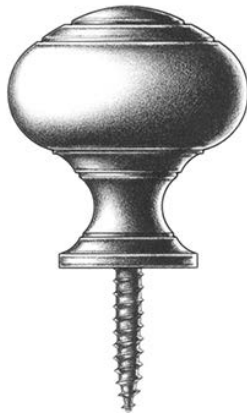

fig. lo

fig. sm

fig. fr

PREMIUM GRADE

Traditional Shutter Knobs
W.C. Vaughan Company Collection

Available in 1 1/4 inch Diameters for Surface Mounting.
Solid Turned Brass Knob.
Standard, Custom Plated and Patinated Finishes Available.

Full Scale

FINE ARCHITECTURAL, BUILDERS' AND CABINETMAKERS' HARDWARE

E. R. BUTLER & CO.



fig. nb



fig. kb



fig. nk

PREMIUM GRADE

Traditional Shutter Knobs
W.C. Vaughan Company Collection

Available in 1 1/4 inch Diameters for Surface Mounting.
Solid Turned Brass Knob.
Standard, Custom Plated and Patinated Finishes Available.

Full Scale

FINE ARCHITECTURAL, BUILDERS' AND CABINETMAKERS' HARDWARE

E. R. BUTLER & CO.



fig. rb

fig. ov

fig. kr

PREMIUM GRADE

Traditional Shutter Knobs

W.C. Vaughan Company Collection

Available in 1 1/4 inch Diameters for Surface Mounting.
Solid Turned Brass Knob.
Standard, Custom Plated and Patinated Finishes Available.

Full Scale

FINE ARCHITECTURAL, BUILDERS' AND CABINETMAKERS' HARDWARE

E. R. BUTLER & CO.

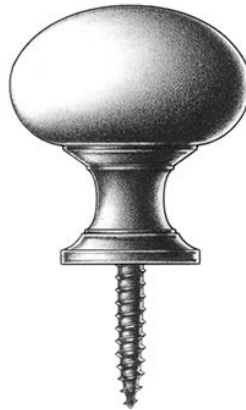
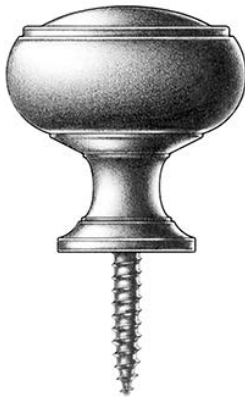

fig. ng

fig. vc

fig. nn

PREMIUM GRADE

Traditional Shutter Knobs
W.C. Vaughan Company Collection

Available in 1 1/4 inch Diameters for Surface Mounting.
Solid Turned Brass Knob.
Standard, Custom Plated and Patinated Finishes Available.

Full Scale

FINE ARCHITECTURAL, BUILDERS' AND CABINETMAKERS' HARDWARE

E.R. BUTLER & CO.

HOOKS

© E.R. BUTLER & CO. ALL RIGHTS RESERVED.

FINE ARCHITECTURAL, BUILDERS' AND CABINETMAKERS' HARDWARE

E. R. BUTLER & CO.

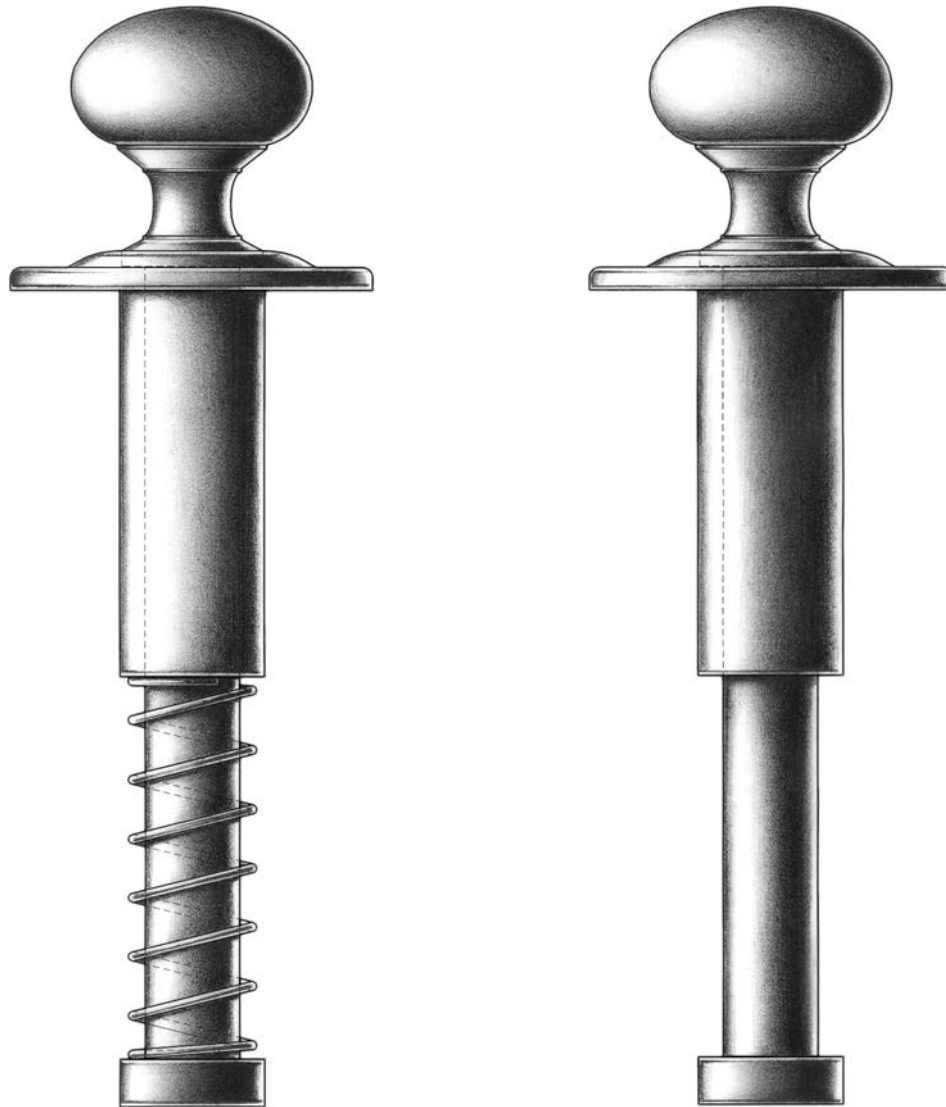

Spring-Loaded

Standard

PREMIUM GRADE

Decorative Telescopic Rods

E.R. Butler & Co. Collection

For Use as Concealed Hooks, Clothes Hangers, Curtain Holdbacks, etc.
May Be Used with Any 1 1/4" Diameter W.C. Vaughan or E. & G.W. Robinson Crystal Cabinet Knob.
(Shown with VC Series Cabinet Knob and VC Ridged Rose.)

Rods are Available in Lengths of 4, 6, 8, 10 and 12 inches.

Teflon Lined for Friction Free Operation.

Standard, Custom Plated and Patinated Finishes Available.

2/3 Scale

FINE ARCHITECTURAL, BUILDERS' AND CABINETMAKERS' HARDWARE

E. R. BUTLER & CO.

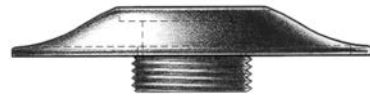

plain

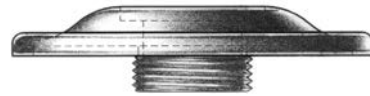

ridged

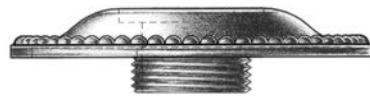
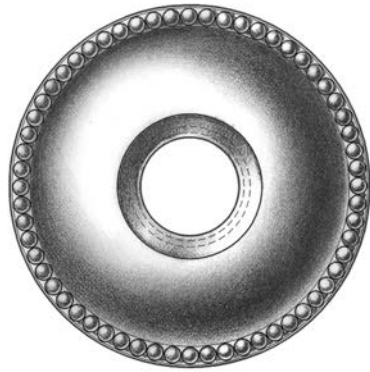

beaded

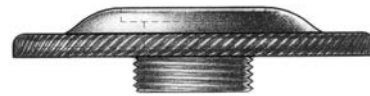

knurled

PREMIUM GRADE

Round Rose Escutcheons

W.C. Vaughan Co. Collection

For Use with Telescopic Rods.
Available with Concealed or Exposed Screws.

2" Diameter Rose (Standard).

Solid Turned Brass.

Standard, Custom Plated and Patinated Finishes Available.

Full Scale

FINE ARCHITECTURAL, BUILDERS' AND CABINETMAKERS' HARDWARE

E.R. BUTLER & CO.

CLOSET & CURTAIN HARDWARE

© E.R. BUTLER & CO. ALL RIGHTS RESERVED.

FINE ARCHITECTURAL, BUILDERS' AND CABINETMAKERS' HARDWARE

E. R. BUTLER & CO.

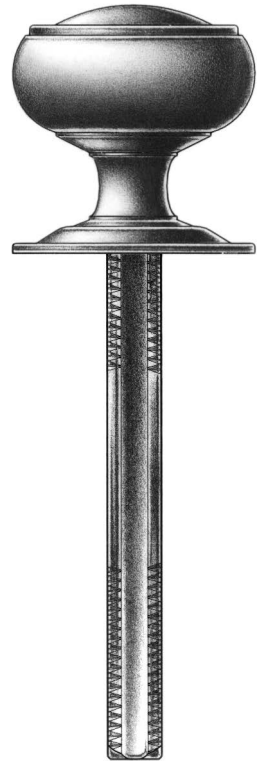
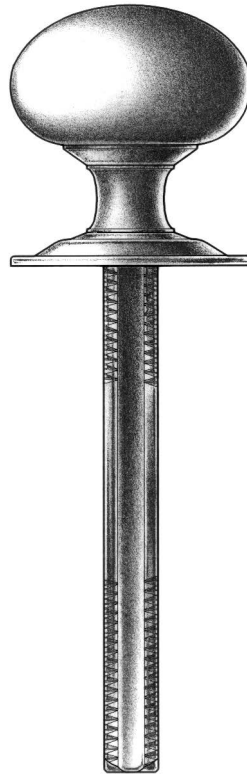
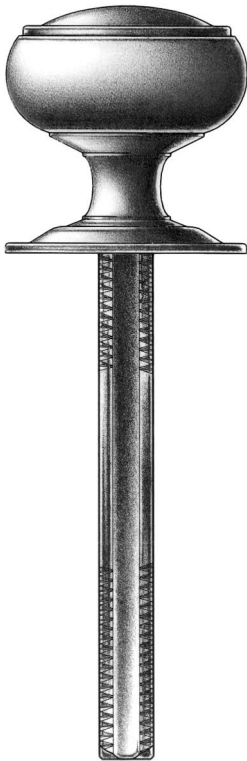
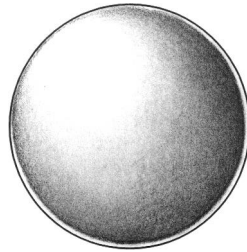

fig. ng

fig. vc

fig. nm

PREMIUM GRADE

Traditional Closet Turns and Roses

W.C. Vaughan Co. Collection

Available in 1¼ and 1½ inch Diameters for Interior Closet Doors.

Standard with ⅜-20 × 4" Spindle.

Regularly Furnished with Two No. 4 × ½" OHWS.

Solid Turned Brass Knob and Rose.

Standard, Custom Plated and Patinated Finishes Available.

Full Scale

FINE ARCHITECTURAL, BUILDERS' AND CABINETMAKERS' HARDWARE

E. R. BUTLER & CO.

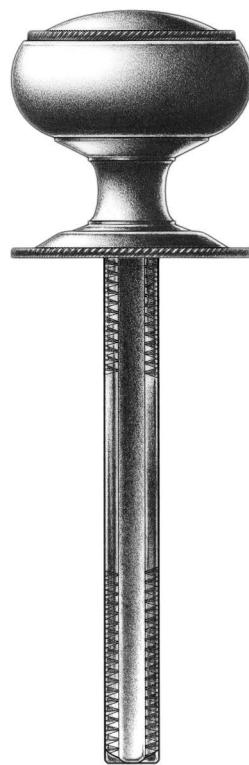
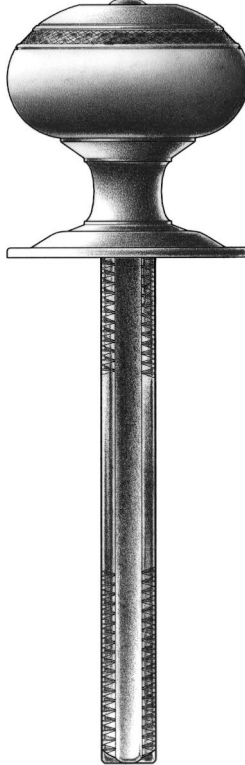
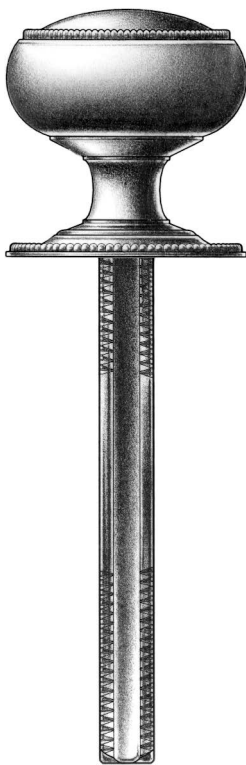

fig. nb

fig. kb

fig. nk

PREMIUM GRADE

Traditional Closet Turns and Roses

W.C. Vaughan Co. Collection

Available in 1 1/4 and 1 1/2 inch Diameters for Interior Closet Doors.

Standard with 3/8-20 x 4" Spindle.

Regularly Furnished with Two No. 4 x 1/2" OHWS.

Solid Turned Brass Knob and Rose.

Standard, Custom Plated and Patinated Finishes Available.

Full Scale

FINE ARCHITECTURAL, BUILDERS' AND CABINETMAKERS' HARDWARE

E. R. BUTLER & CO.

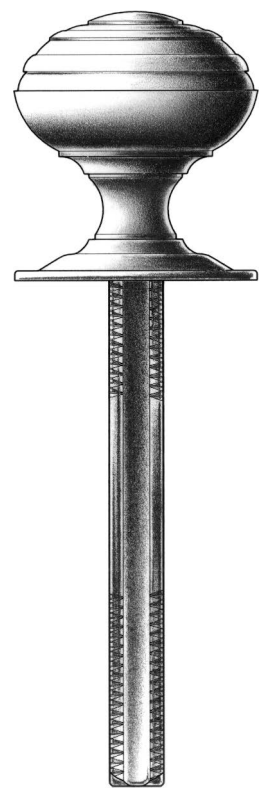
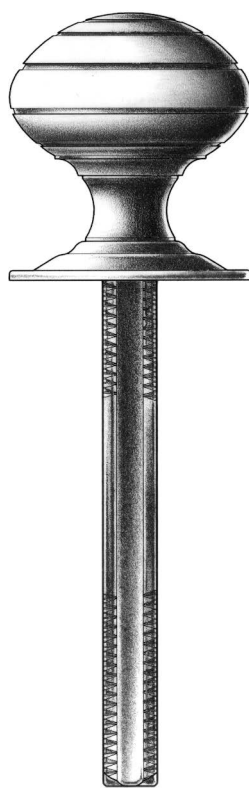
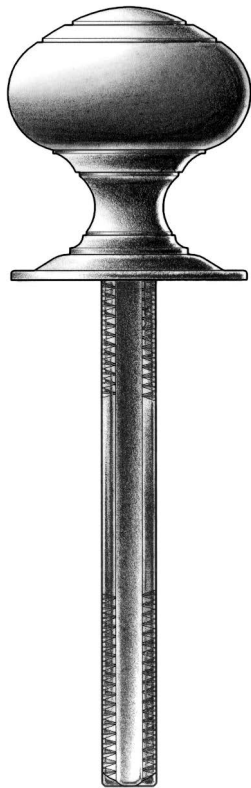
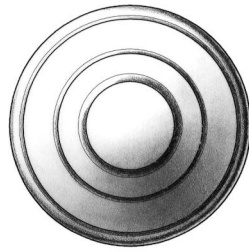
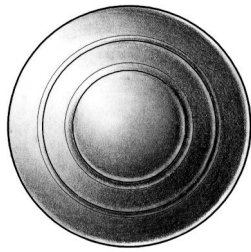

fig. lo

fig. sm

fig. fr

PREMIUM GRADE

Traditional Closet Turns and Roses

W.C. Vaughan Co. Collection

Available in 1¼ and 1½ inch Diameters for Interior Closet Doors.

Standard with ⅜-20 × 4" Spindle.

Regularly Furnished with Two No. 4 × ½" OHWS.

Solid Turned Brass Knob and Rose.

Standard, Custom Plated and Patinated Finishes Available.

Full Scale

FINE ARCHITECTURAL, BUILDERS' AND CABINETMAKERS' HARDWARE

E. R. BUTLER & CO.

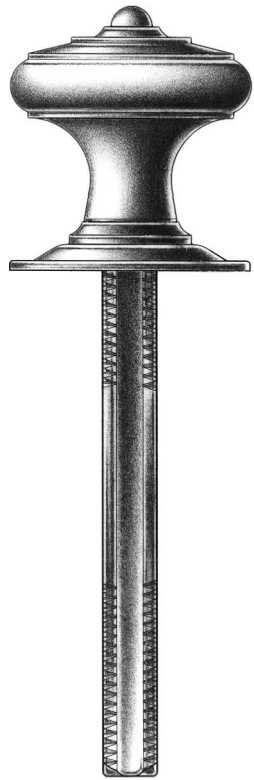
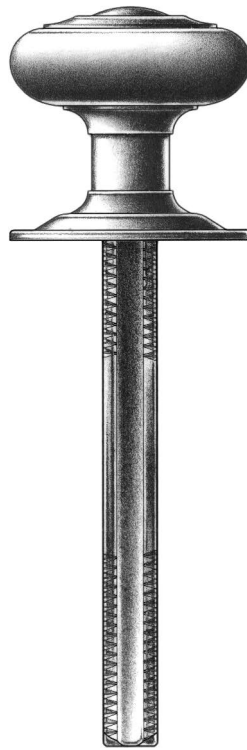
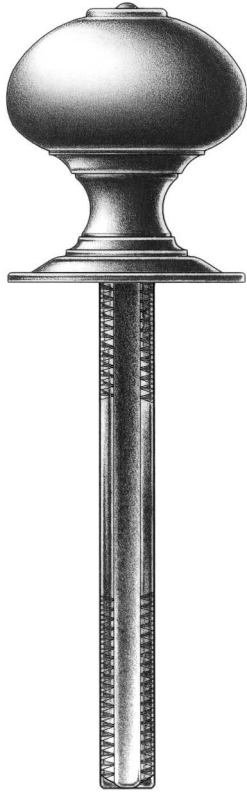
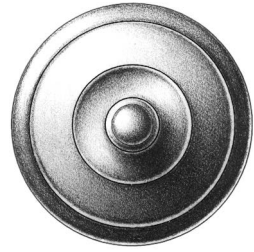
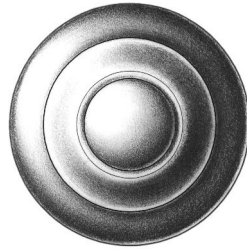
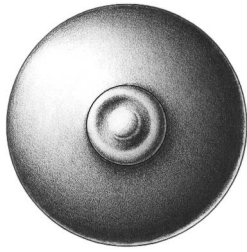

fig. by

fig. do

fig. kb

PREMIUM GRADE

Traditional Closet Turns and Roses

W.C. Vaughan Co. Collection

Available in 1 1/4 and 1 1/2 inch Diameters for Interior Closet Doors.

Standard with 3/8-20 x 4" Spindle.

Regularly Furnished with Two No. 4 x 1/2" OHWS.

Solid Turned Brass Knob and Rose.

Standard, Custom Plated and Patinated Finishes Available.

Full Scale

FINE ARCHITECTURAL, BUILDERS' AND CABINETMAKERS' HARDWARE

E. R. BUTLER & CO.

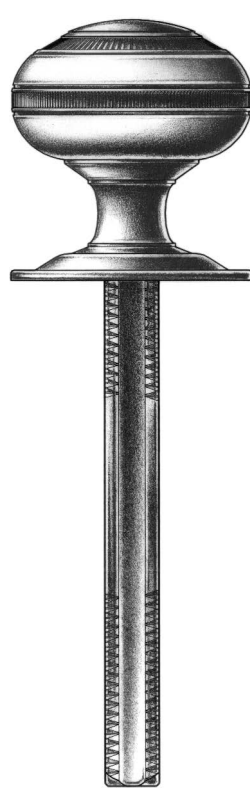
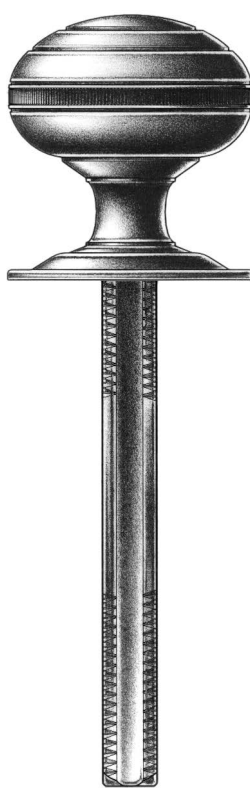
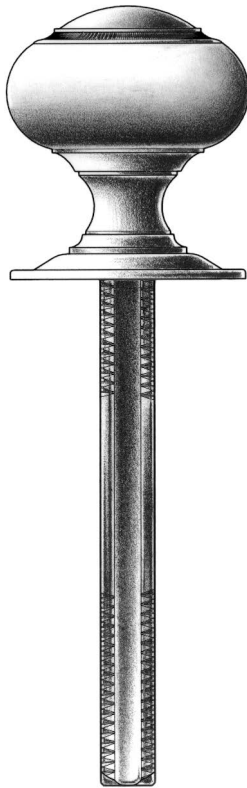
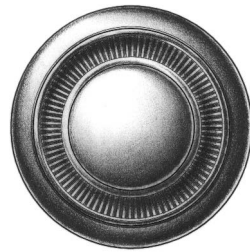
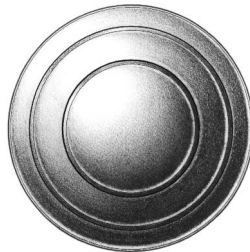

fig. ky

fig. lk

fig. dk

PREMIUM GRADE

Traditional Closet Turns and Roses

W.C. Vaughan Co. Collection

Available in 1¼ and 1½ inch Diameters for Interior Closet Doors.

Standard with ¾-20 × 4" Spindle.

Regularly Furnished with Two No. 4 × ½" OHWS.

Solid Turned Brass Knob and Rose.

Standard, Custom Plated and Patinated Finishes Available.

Full Scale

FINE ARCHITECTURAL, BUILDERS' AND CABINETMAKERS' HARDWARE

E. R. BUTLER & CO.

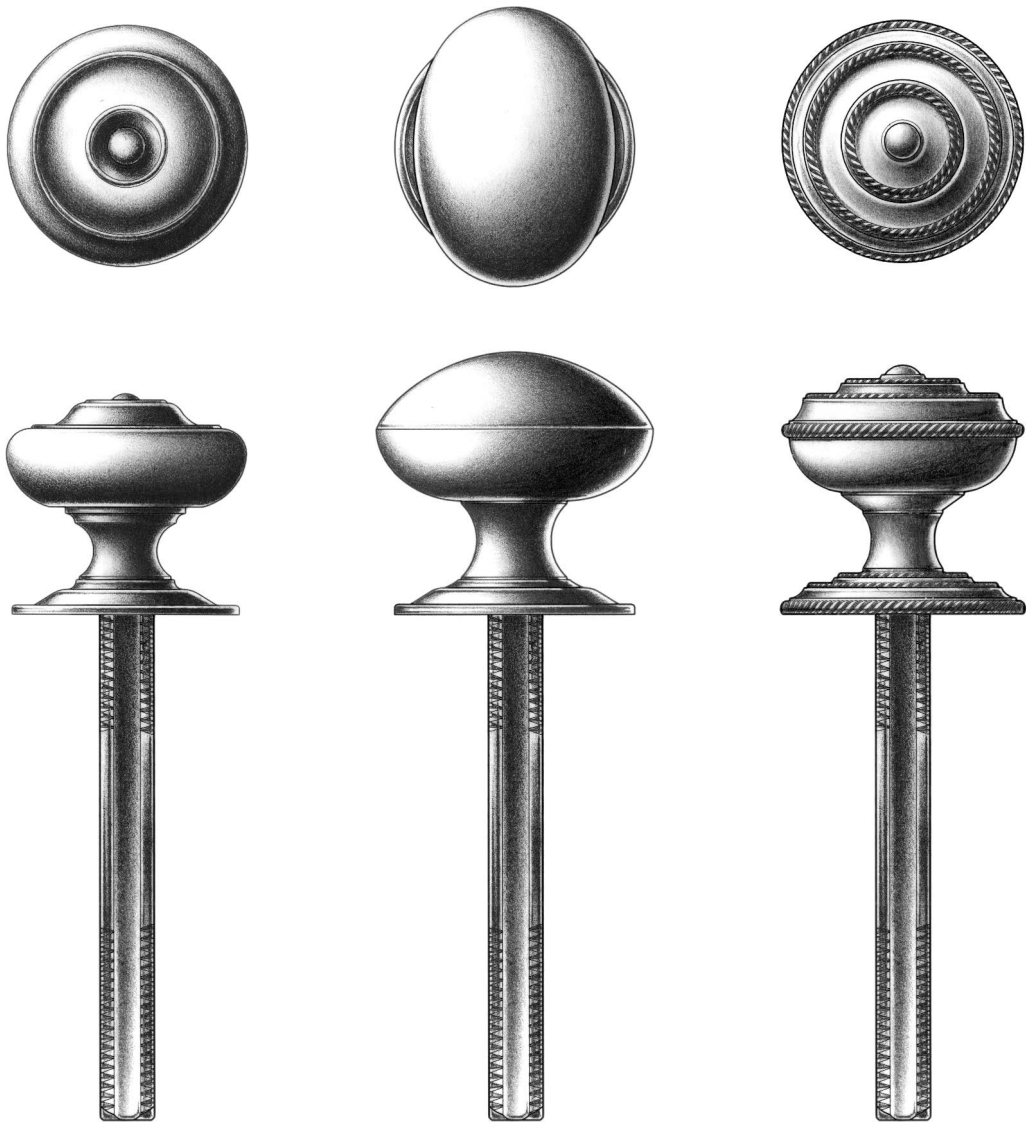

fig. rb

fig. ov

fig. kr

PREMIUM GRADE

Traditional Closet Turns and Roses

W.C. Vaughan Co. Collection

Available in 1¼ and 1½ inch Diameters for Interior Closet Doors.

Standard with ⅜-20 × 4" Spindle.

Regularly Furnished with Two No. 4 × ½" OHWS.

Solid Turned Brass Knob and Rose.

Standard, Custom Plated and Patinated Finishes Available.

Full Scale

FINE ARCHITECTURAL, BUILDERS' AND CABINETMAKERS' HARDWARE

E. R. BUTLER & CO.

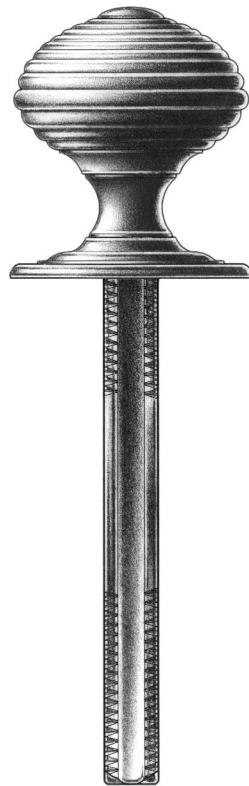
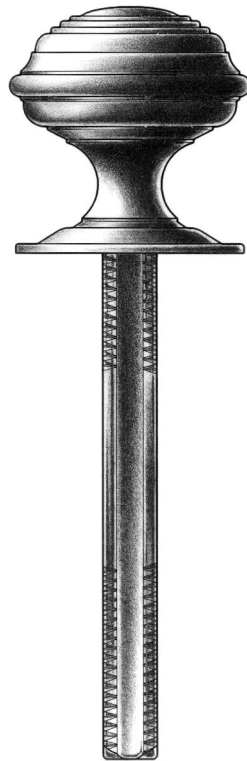
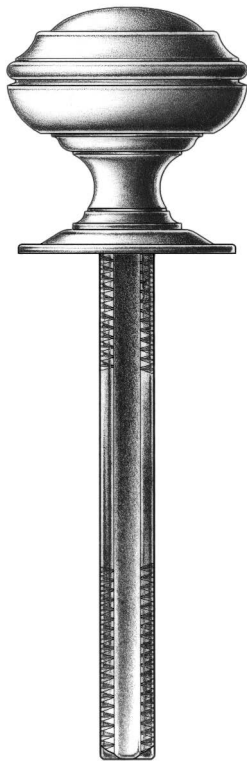
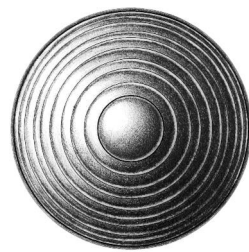
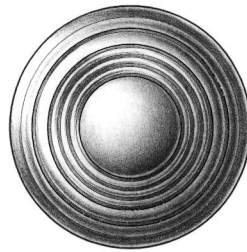
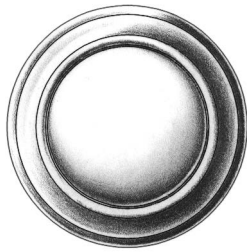

fig. eg

fig. og

fig. en

PREMIUM GRADE

Traditional Closet Turns and Roses

W.C. Vaughan Co. Collection

Available in 1 1/4 and 1 1/2 inch Diameters for Interior Closet Doors.

Standard with 3/8-20 x 4" Spindle.

Regularly Furnished with Two No. 4 x 1/2" OHWS.

Solid Turned Brass Knob and Rose.

Standard, Custom Plated and Patinated Finishes Available.

Full Scale

FINE ARCHITECTURAL, BUILDERS' AND CABINETMAKERS' HARDWARE

E. R. BUTLER & CO.

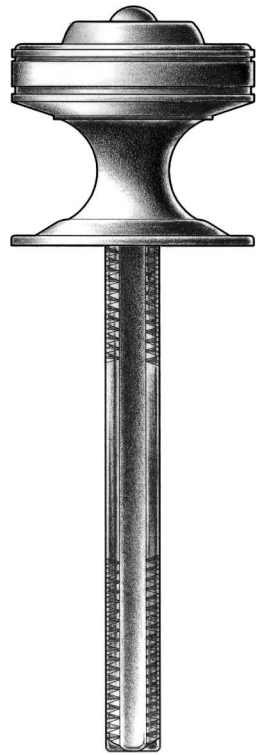
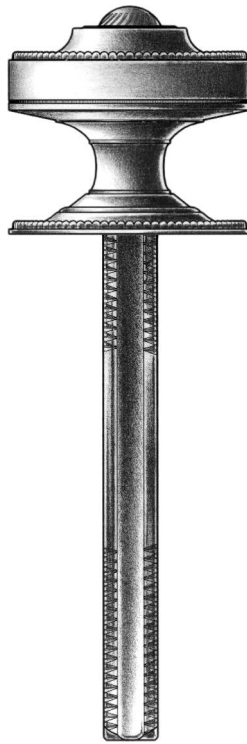
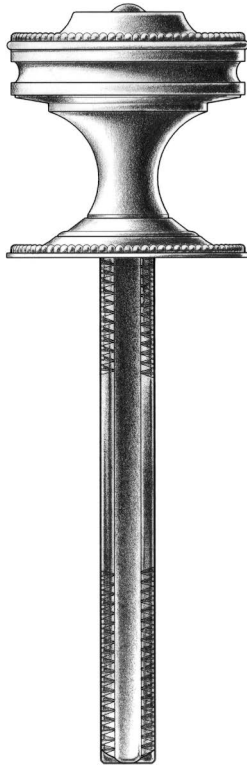
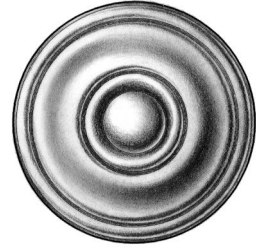
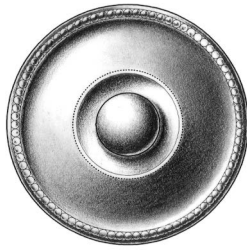

fig. bf

fig. vf

fig. va

PREMIUM GRADE

Traditional Closet Turns and Roses

W.C. Vaughan Co. Collection

Available in 1¼ and 1½ inch Diameters for Interior Closet Doors.

Standard with ⅜-20 × 4" Spindle.

Regularly Furnished with Two No. 4 × ½" OHWS.

Solid Turned Brass Knob and Rose.

Standard, Custom Plated and Patinated Finishes Available.

Full Scale

FINE ARCHITECTURAL, BUILDERS' AND CABINETMAKERS' HARDWARE