

INTERNATIONAL
LIBRARY



INTERNATIONAL
TEXTBOOK COMPANY
SCRANTON, PA.





E. R. BUTLER & CO.
Research Library

Builders' Hardware

By

I.C.S. STAFF

266C

Published by

INTERNATIONAL TEXTBOOK COMPANY

SCRANTON, PA.

Builders' Hardware: Copyright, 1939, by INTERNATIONAL TEXTBOOK COMPANY.

Copyright in Great Britain

All rights reserved

Printed in U. S. A.

THE HADDON CRAFTSMEN, INC.
SCRANTON, PENNSYLVANIA

94935

Original from the **E.R. Butler & Co. Research Library**

CONTENTS

NOTE.—In this list of contents the principal titles are given in the order in which they appear in the book, followed in many cases by synopses of the subjects treated.

BUILDERS' HARDWARE

	<i>Pages</i>
Staple Hardware	1- 13
Nails	2- 4
Screws and Bolts	5- 6
Hardware for Double-Hung Windows.....	7- 13
Sash and lead weights; Sash pulleys; Sash cords and chains; Sash balances; Special sash springs; Weight of sash and glass.	
Finishing Hardware	13-116
Metals and Their Manipulation	13- 14
Hinges, Hinge Butts, and Special Hinges	15- 29
Hinges; Steel hinge butts; Friction butt hinges; Cast- bronze and brass butts; Sizes of hinge butts; Single-acting hinges, or butts; Double-acting hinges; Floor checks and pivots; Outside blind and shutter hinges; Invisible butts, or hinges; Strap and corner hinge plates.	
Locks and Their Appurtenances	30- 54
Locks in general; Rim, mortise, and master-keyed locks; Unit cylinder lock; Locks for residence use; Hotel and office locks; Store-door locks and trim; Padlocks; Cabin- et locks; Care and maintenance of locks; Pottery, wooden, and cast-iron knobs; Stamped and spun-metal knobs; Styles and sizes of knobs; Lock spindles; Screw- less, threaded, wrench, and swivel spindles.	
Door Hardware	55- 67
Door pulls; Push, kick, and sign plates; Door steps and holders; Chain door fastener; Door and mortise bolts; Chain bolts and foot-bolts; Flush bolts; Door closers; Door knockers; Water-closet door trim; Screen-door latches; Secret gate latch.	
Hand and Bevel of Doors and Locks.....	67- 71
Hand and bevel of doors; Mortise locks; Rim locks.	

BUILDERS' HARDWARE—(<i>Continued</i>)		<i>Pages</i>
Hardware for Special Kinds of Doors.....		71- 76
Emergency-exit door; Sliding doors; Accordion doors.		
Window Hardware		76- 79
Sash fasteners and lifts; Sash sockets and pole hooks; Stop-bead screws and washers.		
Casement-Window Hardware		80- 86
Butts; Casement adjusters; Sash-operating devices; Casement bolts and fasts; Cremorne and espagnolette bolts.		
Transom Sash Hardware		87- 91
Shutter and Blind Hardware		92- 93
Cabinet Trim		94- 99
Hinge butts and hinges; Cupboard latches and turns; Cupboard and elbow catches; Bookcase bolt; Lever cupboard catches; Drawer and drop drawer pulls; Card frames, or label plates; Cabinet locks; Cabinet escutcheons; Hinge and corner plates.		
Ornamental Hardware		100-103
Miscellaneous Hardware		104-106
Garage-Door Hardware		107-116
Types of garage-door hardware; Swinging-door hardware; Hinged folding-door devices; Upward-acting door devices.		
Selection and Specification of Hardware for Buildings..		117-124
Customary method of selecting hardware; Method of listing from catalogs; Sample specifications for small work; Hardware schedules; Detail drawings for the hardware contractor; Taking off hardware from plans; Allowance for finishing hardware.		
Application of Hardware		125-128

BUILDERS' HARDWARE

Serial 5373

Edition 1

STAPLE HARDWARE

INTRODUCTION

1. The hardware used in building construction may be classified as *staple* or *rough* hardware and *finishing* or *builders'* hardware.

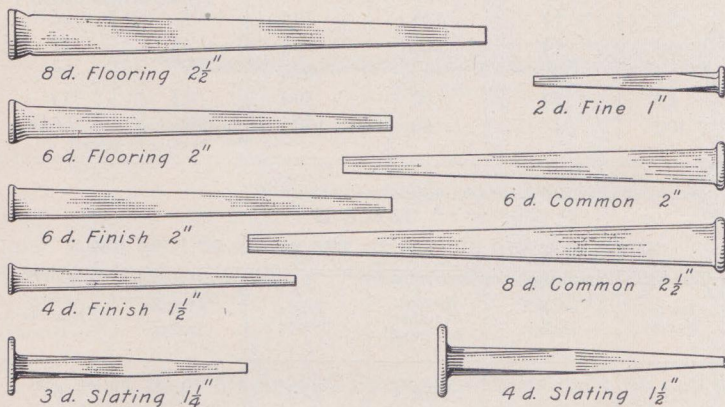

FIG. 1

Staple, or rough, hardware includes such articles as nails, screws, bolts, sash weights, chains, pulleys, and other hardware that is useful rather than ornamental in appearance.

Finishing, or builders', hardware includes locks and latches, hinges, door and window trimmings, and other hardware items that are visible and affect the appearance of a building.

NAILS

2. **Cut Nails.**—Nails are of two general kinds, cut nails and wire nails. Cut nails are cut by machinery from sheets of iron or steel. They are tapered in form and have flat heads. Examples are shown in Fig. 1. The term *penny* or *d* is used in describing nails and is applied according to their lengths. Thus an 8d or 8-penny nail is $2\frac{1}{2}$ inches long; a 2d nail is 1 inch long, etc.

TABLE I
NAME, SIZE, AND NUMBER TO THE POUND OF CUT NAILS

Trade Name	Length in Inches	Approx. Number to Pound	Trade Name	Length in Inches	Approx. Number to Pound
2d	1	667	12d	$3\frac{1}{4}$	44
3d	$1\frac{1}{4}$	448	20d	4	25
4d	$1\frac{1}{2}$	260	30d	$4\frac{1}{2}$	18
6d	2	145	40d	5	16
8d	$2\frac{1}{2}$	90	50d	$5\frac{1}{2}$	12
10d	3	56	100d	8	$6\frac{1}{2}$

TABLE II
NAME, SIZE, AND NUMBER TO THE POUND OF WIRE NAILS

Trade Name	Length in Inches	Approx. Number to Pound	Trade Name	Length in Inches	Approx. Number to Pound
2d	1	876	12d	$3\frac{1}{4}$	63
3d	$1\frac{1}{4}$	568	16d	$3\frac{1}{2}$	49
4d	$1\frac{1}{2}$	316	20d	4	31
6d	2	181	30d	$4\frac{1}{2}$	24
8d	$2\frac{1}{2}$	106	40d	5	18
10d	3	69	50d	$5\frac{1}{2}$	14

Cut nails are heavier than wire nails and there are fewer nails to the pound. They have a greater holding power than wire nails and are more durable. Wire nails are, however, better

than cut nails for use in nailing hardwoods. In the illustration the names and sizes of cut nails are shown. In Table I are shown the names, sizes, and numbers of cut nails to the pound.

3. Wire Nails.—Wire nails are made from drawn steel wire or rods into the shapes and sizes shown in Fig. 2. They are described as 10d, 8d, etc. as indicated in the illustration. Steel wire nails are liable to rust and have less holding power than cut nails. In Table II are shown the names, sizes and number of nails to the pound of wire nails.

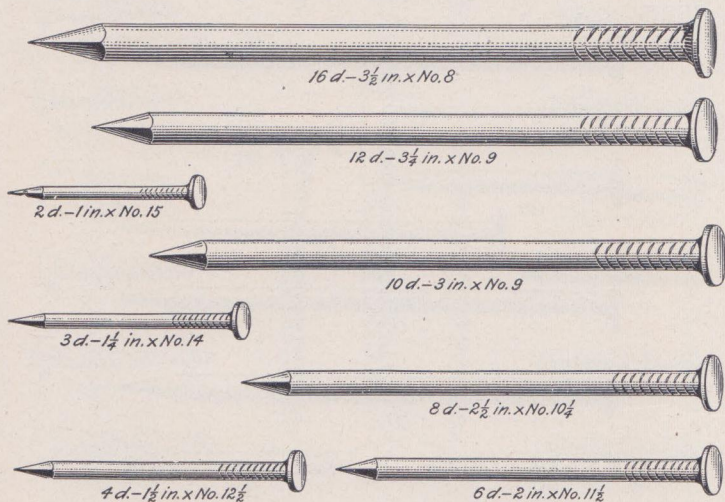

FIG. 2

4. Wire Nails for Special Purposes.—Wire nails, as well as cut nails, are made in a variety of forms for special purposes. Some of these forms of wire nails are illustrated in Fig. 3. At *a* is a finishing nail, at *b* a casing nail, at *c* a common wire brad, at *d* a flooring brad, at *e* a fine wire nail, at *f* a barbed roofing nail, at *g* a slating nail, at *h* a shingle nail, at *i* a fence nail, at *j* a clinch nail, at *k* a dowel pin, at *l* a concrete nail, and at *m* a double-headed nail.

Exceptionally heavy wire nails are made from heavy wire or round rods, and are used for heavy construction work such as

splined flooring and slow-burning mill construction. They are made with chisel points, as shown in Fig. 4, or with diamond points such as shown in Fig. 2.

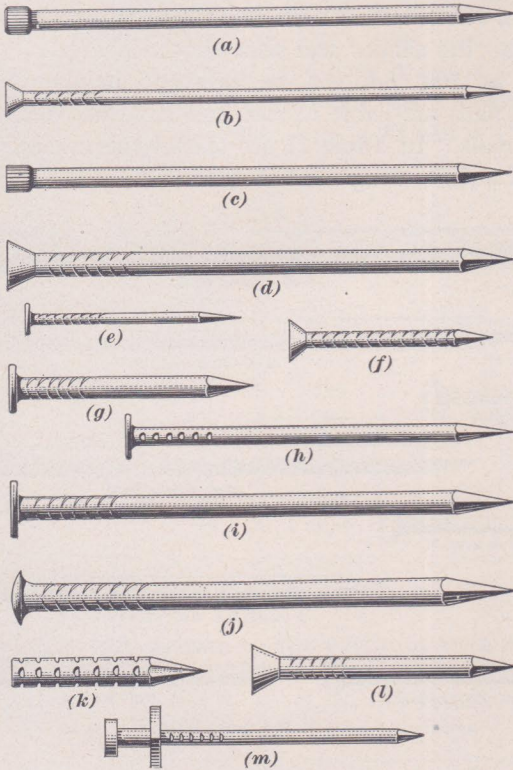

FIG. 3

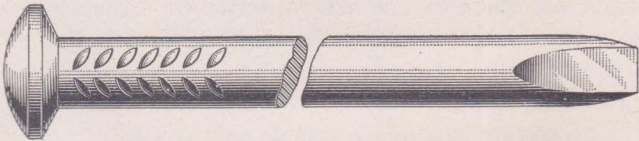

FIG. 4

Wire nails of ordinary sizes may be coated with tin, copper, or zinc, or with cement, to make them rustproof. They may also be made of copper.

SCREWS AND BOLTS

5. **Wood Screws.**—The ordinary wood screw is shown in Fig. 5 and is called a regular flathead screw. Other types of screws are also shown in this illustration. Wood screws

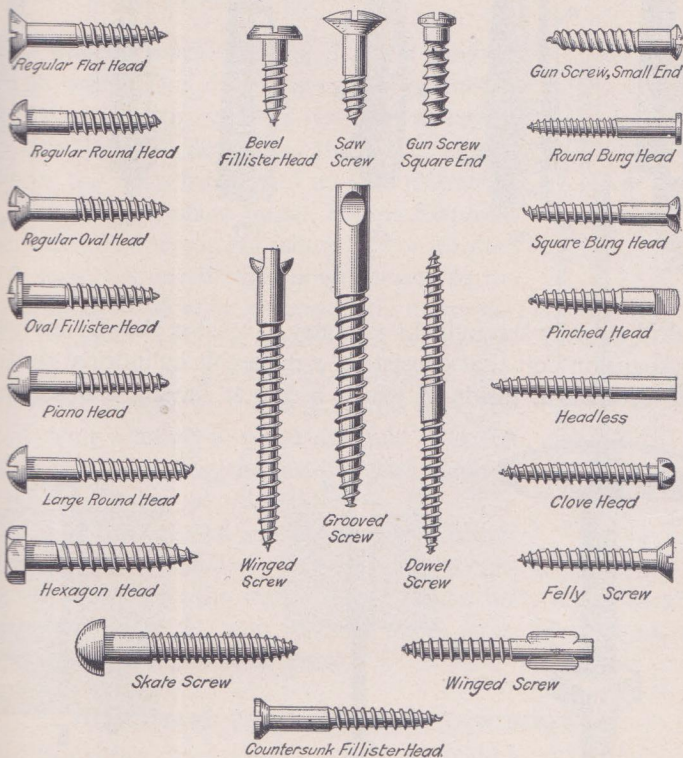

FIG. 5

are made with flat, round, or oval heads and in the following finishes; bright, blued, coppered, silvered, and nickel-plated. They are also made of brass or bronze metal or to match the different finishes in which finished hardware is made. They are used almost entirely to secure finished hardware to the various parts of a building.

6. **Expansion Bolts.**—Several varieties of expansion bolts are illustrated in Fig. 6. They are used to fasten wood and metal to solid masonry construction where it is not desirable

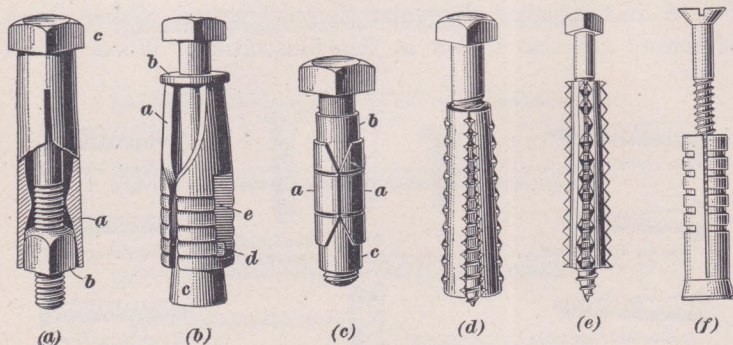

FIG. 6

to drill entirely through the masonry. In (a) is shown one type of expansion bolt that consists of a malleable cylindrical slotted case or shell *a*, inside of which is a bolt having a hexagonal

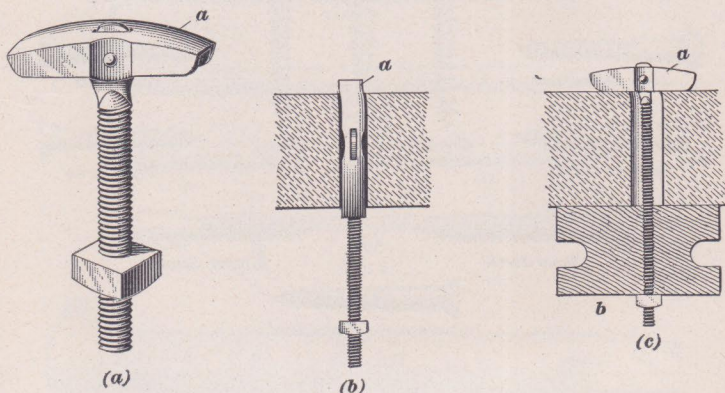

FIG. 7

nut *b*. By turning the head *c* the nut *b* is drawn up into the shell and spreads, or expands, the shell. In using this bolt, a hole is cut in the wall, the shell is inserted, and the material to be bolted to the wall is put in place. The bolt is then put

through the work and into the slot, so that it engages the nut *b*. When the head *c* is turned, the shell expands as the nut *b* is being drawn up, and fits tightly against the sides of the hole. The thickness of the material that is secured to the wall will determine the distance between the nut *b* and the head *c*. The types of expansion bolts shown in (b), (c), (d), (e), and (f) act on similar principles.

7. Special Bolts.—In Fig. 7 (a) is shown a toggle bolt. This device is useful for fastening materials to surfaces having a hollow interior that will not admit the use of expansion or tap bolts because of its frail character, as, for instance, sheet metal, hollow fireproofing, etc. The toggle bolt shown is constructed with long, fine-pitch threads cut nearly to the head, so as to allow for securing thin materials. The T-shaped head *a* is constructed either hollow, as shown, or of a flat strip of metal, and is riveted loosely to the end of the bolt, the head being allowed to pivot and fold over the bolt, thus permitting the head to pass through a small opening as illustrated in (b). The head *a* is then tipped into its proper position as in (c) when the bolt is ready for securing the work *b* to the wall. These toggle bolts are generally made with $\frac{3}{16}$ -, $\frac{1}{4}$ -, and $\frac{5}{16}$ -inch bolts, from $2\frac{1}{2}$ to 6 inches long, and of iron, steel, or brass.

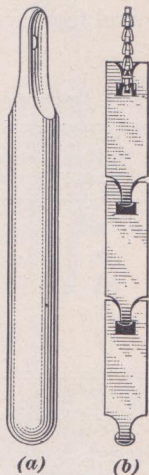

FIG. 8

HARDWARE FOR DOUBLE-HUNG WINDOWS

8. Sash Weights.—The term sash weight is applied to a counterweight used for balancing double-hung, or vertically sliding, sash. The stock sizes are usually long and cylindrical in form, from $1\frac{3}{8}$ to $2\frac{1}{4}$ inches in diameter. They have eyes cast in the upper end, as shown in Fig. 8 (a), and weigh from 2 to 30 pounds, the weight determining the length of the sash weight. In Table III are given the weight, diameter, and length of sash weights as they are generally furnished to the

trade. Square weights or special weights can be easily procured at small additional cost.

9. Lead Weights.—The weight of lead is about 80 per cent greater than that of cast iron; hence, lead sash weights are used where the pockets are too narrow to permit the use of iron weights, or where heavy plate glass is used. They are also used in cases where the sash are very wide and low, as here a short weight must be used in order to obtain the necessary travel for the sash.

TABLE III
WEIGHT, DIAMETER, AND LENGTH OF SASH WEIGHTS

Weight Pounds	Diameter Inches	Length Inches	Weight Pounds	Diameter Inches	Length Inches
6	$1\frac{1}{2}$	14	14	2	18
8	$1\frac{1}{2}$	18	16	2	$20\frac{1}{4}$
10	$1\frac{5}{8}$	$19\frac{1}{2}$	18	2	$22\frac{1}{2}$
11	$1\frac{5}{8}$	$21\frac{1}{2}$	20	2	$24\frac{1}{2}$
12	$1\frac{3}{4}$	20	25	$2\frac{1}{4}$	$25\frac{1}{2}$

Lead weights can be procured in either round or square shapes, and of any diameter or measurement to suit existing conditions, but they are generally made to special order. A wrought- or malleable-iron eye, or fastening, for applying the cord or chain is usually inserted at the top. The cost of lead weights is about five times that of iron weights.

10. Sectional Sash Weights.—There is a form of sash weight in the market which is illustrated in Fig. 8 (b). This weight is so arranged that units or sections of varying weights may be detached or added, as desired, to diminish or to increase the weight. Such a weight can be nicely adjusted to counterbalance any sash.

11. Sash Pulleys.—Sash pulleys are used in window frames of double-hung windows. The sash and the weights that balance it are joined by sash cords or chains which run over the pulleys when the sash is raised or lowered. The pulleys

therefore support the weights of the sash as well as the weights of the sash weights.

The common grades of sash pulleys are rough and cheap. For heavy sash and in important work, a better grade of pulley is required.

In Fig. 9 are shown illustrations of pulleys. In (a) at *a* is the face of the pulley, which may be of steel or brass. At *b* is the case, which supports the pulley wheel. The pulley is fastened to the pulley stile by screws applied through the face. At *c* is the wheel over which the cord or chain runs. The pulley shown in (a) is an open-faced pulley, so called because of the openings at *d*. A closed-face pulley, as in (b), has just enough space in the face of the pulley to permit the sash cord to come through. This is further illustrated in (c), in which the pulley is shown with part of the case removed. A high-grade pulley wheel made of stamped metal is illustrated in the sectional view (d). It is put together either by riveting the halves together or by electrically welding them. In this section is shown a pulley with an all-steel bearing for the axle.

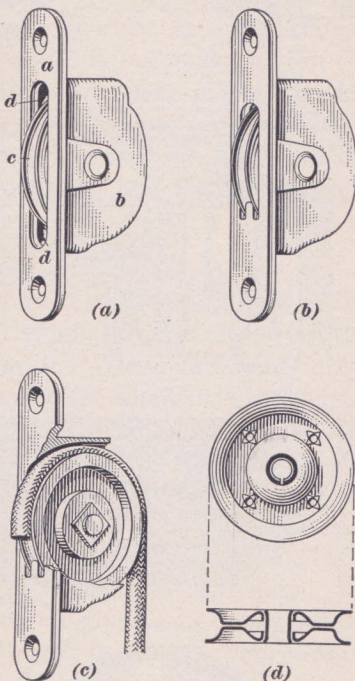
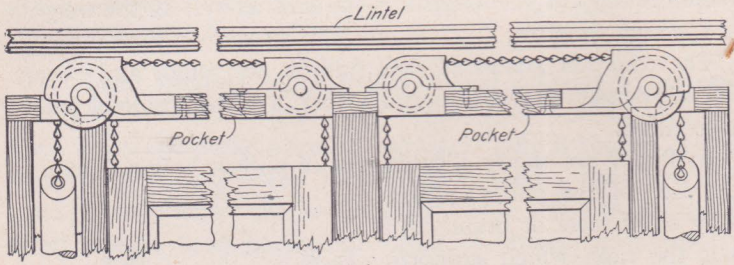
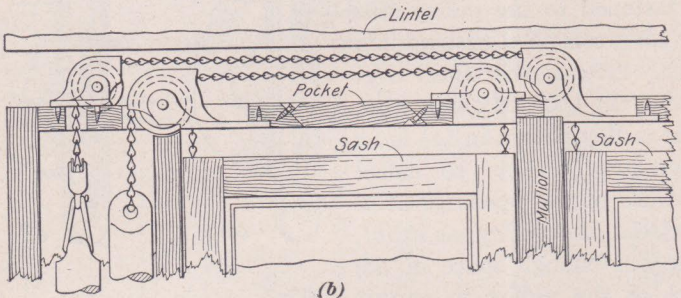

FIG. 9

12. Overhead Sash Pulleys.—There is a special type of sash pulley that may be used for twin or triple windows, where it is necessary to form a narrow mullion between the windows, instead of using boxes between the windows to contain the sash weights.



(a)



(b)

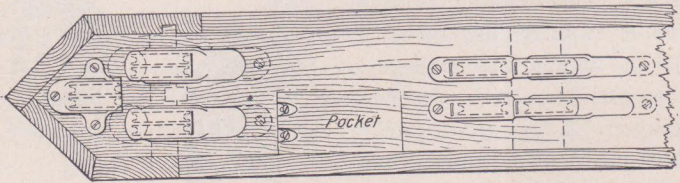

(c)

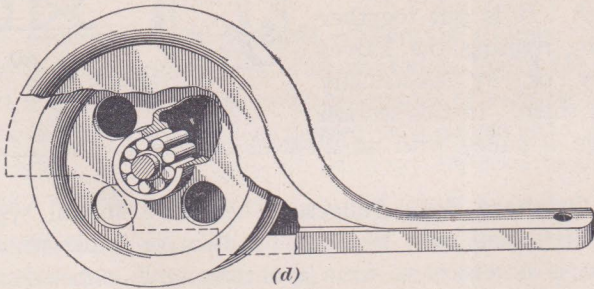

(d)

FIG. 10

Pulleys of this type are known as *overhead sash pulleys*, and are used as illustrated in Fig. 10. In (a) is a twin-window arrangement, showing double-hung windows on the two sides, each sash being counterbalanced by means of one counterweight. By this means, the frame mullion between the two sashes can be made as narrow as 2 inches, which is an advantage where the maximum amount of daylight opening is desired. Frequently, in triple windows, the center as well as the two side windows is made double-hung. In such a case, the arrangement of the overhead pulleys would be as shown in (b). A top view of the frame is shown in (c). These pulleys provide a convenient means of arranging double-hung windows of this type, but sufficient room must be left in the head of the window to allow for the insertion of this pulley and the travel of the cords or chains. The construction of this type of overhead pulley with the roller bearings is shown in (d).

13. Determination of Size of Sash or Frame Pulleys.—The architect's specifications should stipulate the diameter of the sash pulleys to be used in the work. Where care is not exercised, either the pulley wheel will be so small that the weight will rub against the pulley stile, or it will be so large that the weight will rub the back lining on the opposite side of the pocket. In determining the diameter of the pulley wheels required for a particular window frame, a good rule is to multiply the thickness of the pulley stile by 2.25. Thus, a $\frac{7}{8}$ -inch stile would require a 2-inch pulley wheel; a $1\frac{1}{8}$ -inch stile, a $2\frac{1}{2}$ -inch pulley wheel; and a $1\frac{3}{8}$ -inch stile, a 3-inch pulley wheel. It is best to specify that pulley wheels for metallic frames shall be of the larger size, namely, 3-inches in diameter; and also that they shall have $\frac{3}{8}$ -inch axles.

14. Sash Cords and Chains.—The sash cords by which the sashes are attached to the counterweights in double-hung windows may be specified under staple hardware. For good standard work Samson Spot or Silver Lake sash cords are the best that can be procured. Table IV will be found convenient in determining the diameter of the cord and the consequent size by number, as well as the size of the sash pulleys.

TABLE IV
STANDARD SIZE OF SASH CORD FOR PULLEYS

Size No.	Diameter of Cord Inch	Average Weight per Dozen Hanks Pounds	Average Number of Feet per Pound	Heaviest Weight to Be Used Pounds	Smallest Pulley to Be Used Inches
6	$\frac{3}{16}$	18	66	5	$1\frac{1}{2}$
7	$\frac{7}{32}$	22	55	15	$1\frac{3}{4}$
8	$\frac{1}{4}$	27	44	25	2
9	$\frac{9}{32}$	33	36	35	$2\frac{1}{4}$
10	$\frac{5}{16}$	44	27	45	$2\frac{1}{2}$
12	$\frac{3}{8}$	60	20	55	3

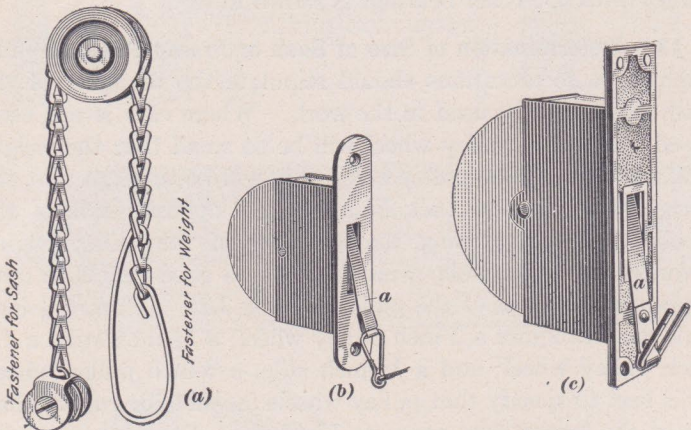

FIG. 11

Sash chains are made in the form illustrated in Fig. 11 (a) and may be had either in steel, red metal, or bronze. The sash chains in the market are usually made in four sizes, being numbered from 0 to 3. When specifying, it is well to name the maker of the chain. The lightest sash chain will support sash weighing from 40 to 75 pounds, while the heaviest will carry sash that weigh from 150 to 250 pounds.

15. **Sash Balances.**—By the use of sash balances, such as shown in Fig. 11 (b) and (c) there is no necessity for weight boxes, counterweights, etc. They are constructed with long, spiral springs and thus raise the sash. The coil springs in these balances are made of either light or heavy metal, according to the weight of the sash it is intended to counterbalance.

16. **Special Sash Springs.**—Various other types of devices are on the market. These devices consist mainly of springs which more or less balance the weight of the sash, and permit the sash to be easily raised or lowered. In some cases, the entire window, including the frame, sash, and springs, is assembled at the factory and is shipped to the job ready for installing.

17. **Weight of Sash and Glass.**—The best practice in counterbalance sashes is to weigh the sash after it has been glazed; in this manner the exact weight and size of the counterweights required can be determined. The approximate weights of ordinary glazed sash are usually given in the catalogs of manufacturers of sash weights, pulleys, etc., and will be found convenient in determining the approximate weight of sash weights.

FINISHING HARDWARE

METALS AND THEIR MANIPULATION

18. **Metals Used in Hardware Manufacture.**—The metals chiefly used in manufacturing the products of the smiths' art are iron and steel and the copper alloys known as brass and bronze. Iron remains as the chief material of construction for all the cheaper grades of hardware, while brass and bronze are more generally used for "destructible," or wearing, parts and the finer and more elaborate decorative work. These alloys also adapt themselves admirably to the great variety of finishes that are now in vogue. Iron is also used considerably for elaborate decorations in wrought and cast designs, and is very desirable in the "rustless-iron" finish.

19. **Commercial and Stock Designs.**—Manufacturers produce beautiful and elaborate hardware in the several styles of ornament, and the most exacting critic can now select

artistic designs from the manufacturers' catalogs. The finishes are made to harmonize or contrast with any color treatment.

The principal hardware manufacturers can provide from stock, locks, hinges, and escutcheons finished in any manner and designed in any of the following styles of architectural ornament. They will also provide hardware in special designs from sketches furnished by the architect, including armorial or emblematic designs, if required. Several of these styles of ornament are here arranged in alphabetical order.

Adam	Gothic, English
Colonial	Gothic, French
Elizabethan	Gothic, German
Empire	Greek
Flemish Renaissance	Indian
Francis I	Italian Renaissance
French Renaissance	Louis XIV, XV, and XVI
	Romanesque

20. Finishes.—The basic metals upon which are applied the variety of finishes now obtainable, are iron, steel, brass, bronze, and white metal, of which the last three are the most durable. These metals will not rust or corrode when exposed as will iron or steel, and when tarnished can be readily cleaned and polished.

Nearly all the fancy finishes are obtained by electroplating and acid treatment on the natural metals, the finish being then lacquered to preserve it. Some of these finishes are very attractive and desirable, but where exposed to constant usage, have not the durability of the natural metals, as they cannot be polished or cleaned without the finish being injured or destroyed.

Many architects or owners purposely select applied finishes with the object in view that they will need little attention. When selections are being made for exterior purposes or where there is likely to be excessive handling, it is best to select the darker shades with sanded surfaces. For interior purposes, the more delicate finishes are desirable for the decorative effect; they also wear reasonably well.

The variety of colors and shades of finishes is exceedingly large, and the choice of color, like that of texture, depends on the character of the design and on the personal taste of the one making the selection.

The standard finishes that can be had are numerous. Many of them may be obtained in various shades of oxidation and in from one to four different textures of surface. Popular finishes are as follows:

Pompeian bronze	Copper
Sage-green bronze	Nickel
Royal copper bronze	Silver
Ormolu metal	Gold
Boston finish	Bower-Barff
Enameled	White enamel
Japanned	Gun-metal brown
White meta ¹	Verde antique
Brass	Statuary bronze
Bronze	Polychrome
Chromium	Cadmium

HINGES, HINGE BUTTS, AND SPECIAL HINGES

21. Strap Hinges.—The forms of hinges shown in Fig. 12, (a) and (b) are used to hang the doors of bins, sheds, barns, etc., where strong serviceable hinges are required. They are known as strap hinges. They are stamped or cut from sheets of wrought metal of various thicknesses according to the size of the hinge. Knuckles *a* are formed on the straps or leaves *b* of the hinges. Pins *c* pass through the knuckles as shown and are riveted in place. There are two kinds of strap hinges light-strap and heavy-strap hinges.

The light-strap hinge, which is shown in (a), is so termed because of its light construction. This hinge is made in inch sizes, varying from 3 to 16 inches in length. By inch size is meant the longest dimensions when the hinge is closed; thus, a 6-inch strap hinge is 12 inches long from end to end when opened.

The heavy-strap hinge, shown in (b), is similar to the light hinge, but is made from heavier metal and has large dimensions at the joints, or knuckles. This type of hinge is used where a

strong, substantial hinge is required. The heavy-strap hinge is made in inch sizes, from 4 to 16 inches long. As shown in (b), the heavy-strap hinges are also made with corrugated

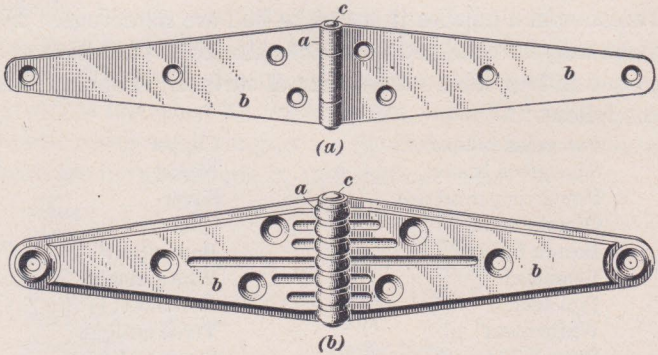

FIG. 12

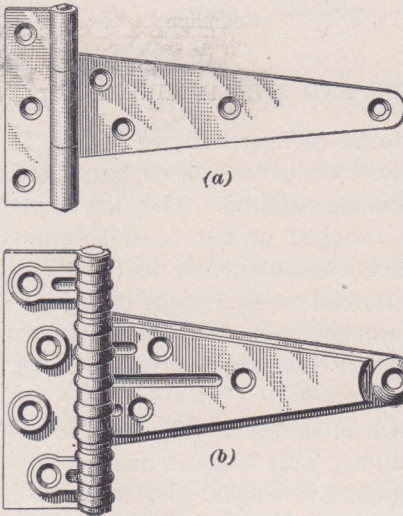

FIG. 13

knuckles, which give additional strength where the construction is weakest. These are termed corrugated-strap hinges.

All of the hinges described are also made in plain steel, japanned or galvanized, and may have brass pins or rivets.

22. T Hinges.—As will be seen from Fig. 13, T hinges are so called because of their shape, which is in the form of the letter T. The T hinge (a)

is used for practically the same purpose as the strap hinge. T hinges are made in light, heavy, and extra-heavy grades. In arranging the sizes of T hinges, the measurements are given for the length of the strap only; the leaf of the hinge forming

the **T** with the strap is not considered. Thus, a 6-inch **T** hinge measures 6 inches from the pin to the end of the strap leaf. **T** hinges may also be obtained in stamped metal, with corrugations, as shown in (b). These hinges can be had in all finishes. The light and heavy grades as well as the 4- and 5-inch extra-heavy grades are sold by the pair, while the larger sizes of extra-heavy are sold by weight.

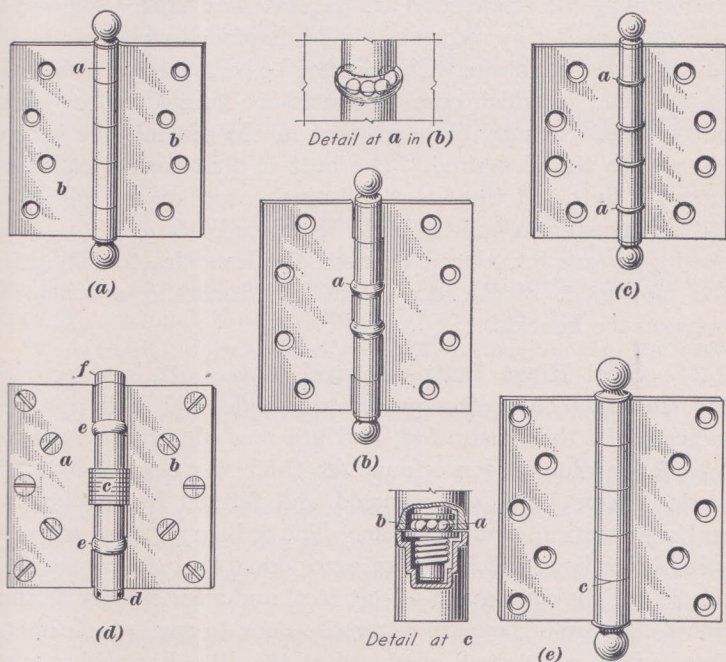

FIG. 14

23. Hinge Butts.—This type of hinge is used for the purpose of hanging all exterior and interior doors of buildings, and is usually secured to the edge of the door and to the hanging stile of the frame with screws, the greater part of the appliance being hidden from view. The hinge butt supports the entire weight of the door and, ordinarily, is constantly in use, so that it is subjected to great strain and considerable wear. It is evident, therefore, that great care should be exercised in

selecting hinge butts, so that proper sizes and qualities suitable for the purpose intended may be obtained.

In Fig. 14 (a), (b), (c), (d), and (e) are shown illustrations of hinge butts. The vertical cylindrical portion *a* in (a) and (b) is known as the knuckle. Some butts have three knuckles and are known as three-knuckle butts. Most butts have five knuckles and are known as five-knuckle butts. The flat parts *b* containing the screw holes are the leaves or flaps. The flaps are held together by means of a solid, hardened steel pin about which the leaves rotate. The pin may be permanently attached to the butt, in which case the butts are known as fast-joint butts. The pin may be loose, that is, the pin may be taken out at the top if desired. The butt in that case is called a loose-pin butt. If there is a ball on the top of the pin, the butt is known as a ball-tip butt. In some butts as in (b), ball bearings *a* are introduced between the knuckles to facilitate the movement of the door. In (c) washers *a* are placed between the knuckles.

24. Steel Hinge Butts.—A steel hinge butt is shown in Fig. 14 (a). The better grades are made with ball tips, as indicated in the illustration, and are now almost universally used for medium-class work and for the better class of interior work. These butts are stamped and formed by machinery and are practically unbreakable. The ordinary grades are not suitable for large and heavy entrance doors that are constantly in use, for they are made of soft steel and wear readily at the joints. In time they will allow the door to sag, which must therefore be readjusted, or planed at the sill. For such work, steel hinge butts should be used that are provided with ball bearings, as shown in (b), or with hardened-steel washers inserted at the joints, as shown in (c).

These steel butts are also made in smaller sizes for bookcases and cupboard doors.

25. Friction Butt Hinges.—A type of hinge known as the friction-butt hinge is used on doors when quiet operation is essential, as in hospitals, hotels, etc. The hinge is designed to hold the door open at any angle, and to prevent the door from

slamming. A friction butt hinge is shown in Fig. 14 (*d*). This hinge consists of the two leaves *a* and *b*. Friction disks *c* of alternate bronze and hardened steel are held together as a unit by means of a hardened-steel bushing, the entire unit being attached to one leaf of the hinge. A hardened-steel pin extends through the knuckles, and this pin has a shoulder which rests on the bushing of the friction unit. When the bottom tip *d* is screwed up, the shoulder is drawn down against the bushing, which in turn compresses the disks. This produces a degree of friction ranging from practically nothing to an amount that makes it just possible to move the door.

Friction butt hinges are made in a number of sizes, so as to be used on doors of any weight or size.

The weight of the door is carried on ball bearings in the races at *e*. The friction unit is independent of the bearings, and is used only to provide friction, or resistance to opening or closing the door. Through an oil hole in the tip *f* the disks and the ball bearings are oiled, thus assuring noiseless operation.

When these hinges are used with the proper tension, the door may be left open in any position, and it will remain in that position with no danger of being blown shut or open.

26. Cast-Bronze and Brass Butts.—All types of brass and bronze butts are made in several grades and qualities, and it is difficult to determine the grade after they have been placed in position. It is therefore advisable for the architect or building superintendent to make a careful inspection of this hardware, to determine whether it is furnished according to specification. Brass and bronze butts are made in light, or commercial, heavy, and extra-heavy grades, and in all cases should be steel-bushed, self-lubricating, and provided with five knuckles. The high-grade butts are now manufactured with ball bearings at the wearing joints. The construction of a solid bronze, ball-bearing hinge butt is shown in Fig. 14 (*e*). The knuckle *c* is shown in the detail view, in which the hardened-steel balls are shown at *a*, and the cones, which are also of hardened steel, at *b*. Bronze hinges constructed in this manner can be obtained at a slight additional cost above the ordinary steel-bushed hinge.

Where hinge butts are exposed to the weather, as when used for exterior doors, bronze or brass butts should always be employed; and for extra-heavy doors that are in constant use, only the extra-heavy types should be used if permanency and durability are desired. There are a number of cheap grades of

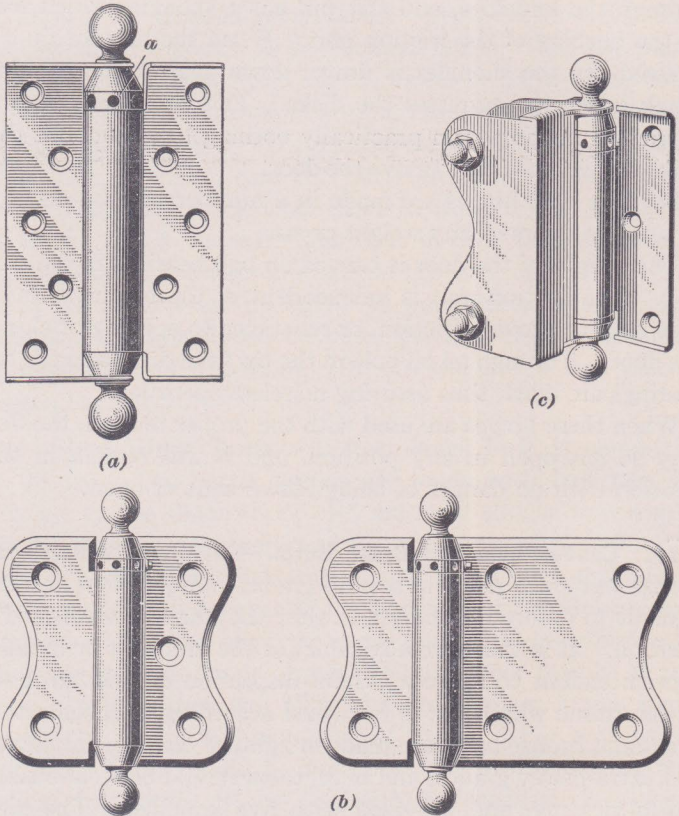

FIG. 15

bronze, steel-bushed hinges on the market that are made of wrought or sheet metal. This kind of hinge has no merit, and should not be used on work of any quality.

27. Sizes of Hinge Butts.—The standard hinge butts are always square, but they may be procured in irregular sizes at

additional cost. In indicating the size of irregular hinge butts—that is, the butts that are not square, and that are consequently not standard—two dimensions must always be given. The first dimension stated should indicate the height of the butt, and the second the width of the butt when it is open. Thus, a 6'' \times 5'' butt is 6 inches high and 5 inches wide when opened. This rule for indicating the size of hinge butts is easy to remember, from the fact that it is the reverse of that ordinarily employed by builders when indicating the sizes of doors and windows, for in carpentry it is customary to give the horizontal dimension first and the height of the opening last.

28. Single-Acting Hinges, or Butts.—There is a butt hinge in the market that has a coil spring either between the knuckles, or enclosed between the leaves. This device is known as the single-acting hinge and is illustrated in Fig. 15. In (a) is shown the Bommer single-acting hinge, which has a spiral spring enclosed within the casing formed by one of the knuckles. The tension on this spring can be increased by turning the collar at *a* with a pin, or bar. This kind of single-acting hinge is representative of several hinges of the same nature now in the market, but for doors of large size the liquid door check is preferred, although it is more costly. Single-acting hinge butts are used principally for hanging water-closet slat doors; and they are also used for light doors that do not reach the full height of the opening, and which have no jambs. The Bommer hinge, as shown in Fig. 15 (a), has an advantage on account of the simple means provided for adjusting the tension of the coil, or spring, by which the momentum of the door in swinging to and fro can be reduced to a minimum, thus shutting the door with little noise as it strikes the stop.

Two other types of the Bommer single-acting spring hinge are shown in (b) and (c). In (b) are shown two types of single-acting, surface, spring hinges that are used for lavatory doors, while in (c) is shown a similar single-acting spring hinge arranged for securing to a marble or slate stile or partition. These hinges are commonly supplied in highly polished nickel plate, brass, or bronze. The clamp hinge illustrated in (c) is made

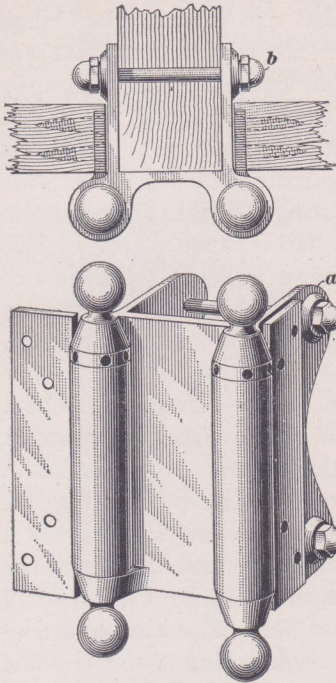

FIG. 16

to secure to slabs of marble or slate from 1 to 2 inches in thickness, advancing by quarter inches. This type of hinge is also adjustable $\frac{1}{8}$ inch over and under the stated sizes.

The B o m m e r yoke-spring hinge is also made as illustrated in Fig. 16. This yoke hinge consists of two single-acting hinges hung right and left of the same partition on one box flange, the yoke or box flange being constructed as shown at *a*. As the box flange of this spring is not adjustable, the exact thickness of the marble, or partition, and the door must always be stated in ordering these hinges.

The single-acting spring hinges with clamps, as just

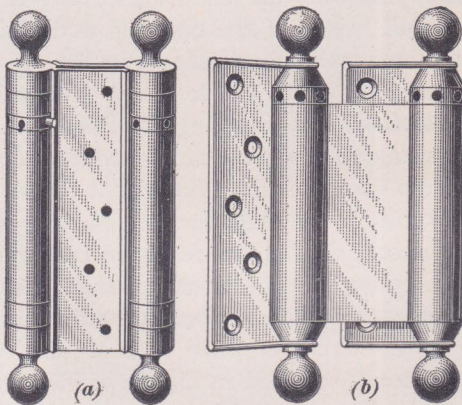

FIG. 17

described, are fastened to the marble partitions separating water-closet compartments by means of bolts having capnuts, as shown at *b*, and are thus secured firmly in position. Special single-acting hinges may be obtained with a reverse spring that can be regulated to hold the door partly open, instead of in a closed position.

29. Double-Acting Hinges.—The double-acting hinge is similar in construction to a single-acting hinge, except that it is arranged so that the door can swing both ways. These hinges are combined in one piece of hardware, as illustrated in Fig. 17 (*a*) and (*b*). Such hinges are much heavier and more costly than the single-acting hinge, and they are generally used for entrance doors of hotels and public buildings, and for doors between kitchen and pantry or dining room in private residences, where a door that will swing both ways and return to a closed position is desirable. The double-acting hinge is usually subjected to excessive wear and strain. Care should therefore be exercised in selecting this type of hinge; also, in determining the size, it is better to have a hinge slightly larger than required rather than one that is too small. While double-acting spring hinges made of cast iron may be obtained, those of the latest manufacture are of steel. They may also be procured in brass or bronze, and of any desired finish to match the fixtures and other hardware.

30. Floor Checks and Pivots.—Devices made for closing single- and double-swinging doors hung on pivots placed at the top and bottom of the door are called floor checks or checking floor spring hinges.

The top pivot used in hanging the door may be simply a pin, as at *a* in Fig. 18 (*a*), turning in a socket supported by the plate *b*. This type is commonly used with single-swinging doors. With double-swinging doors the top pivot may be arranged as in (*b*), in which the bolt *a* is held in a socket in the head jamb and may be lowered into a socket in the top of the door by means of the walking beam *b*, which is adjusted by the screw *c*. By raising the bolt above the lower socket the top of the door is freed. The lower pivot usually works on a ball

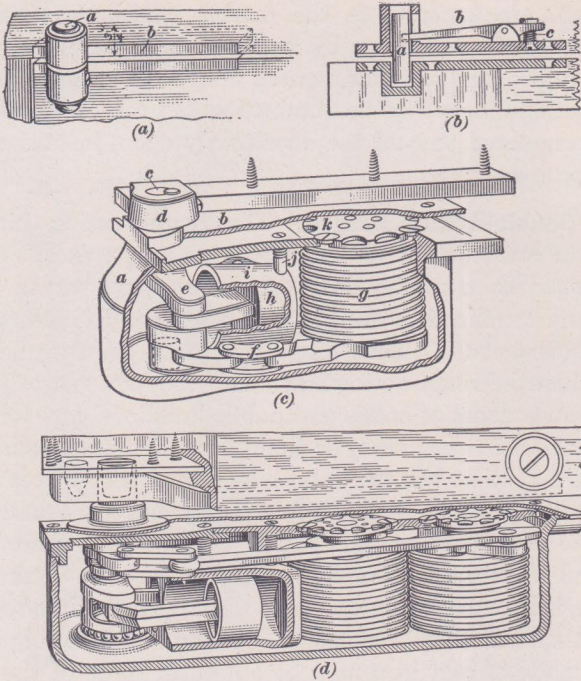

FIG. 18

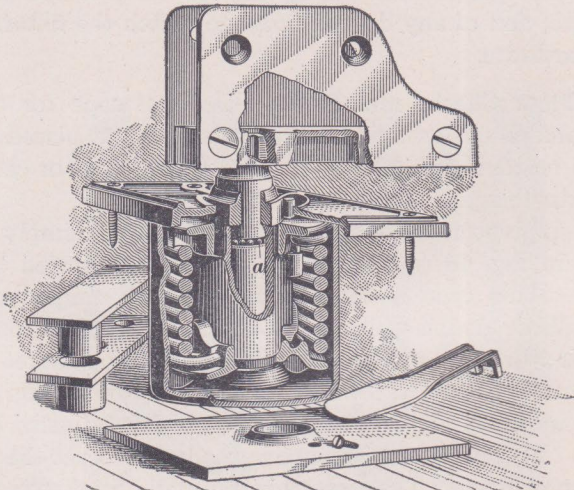

FIG. 19

bearing and takes the weight of the door, and is arranged in connection with a mechanism for closing the door positively and silently, as in (c) and (d).

In (c) is shown a floor check for a single-swinging door. This mechanism is contained in a metal case, or box, *a*, set in the floor or threshold, the top plate *b* being flush with the floor or threshold. The operating bar is connected with the pivot *c*, which is fixed in the socket plate *d* on the door and is connected with the mechanism in the case by means of a crank *e* and a connecting link *f*. The case is filled with oil or other non-freezing liquid. The action of the door in opening compresses the spring *g* and draws out a piston *h* in a cylinder *i*, causing the cylinder to fill with oil. The spring operating to close the door also moves the piston in the cylinder, and the oil in the cylinder is forced out through a by-pass, the rate of flow being regulated by the adjusting screw *j*, which is on a level with the top plate of the case. The tension of the spring can be adjusted by means of the plate *k*. With this device the door is closed surely and gently. Floor checks of this type can be used on the regular door frame. The pivot at the top, as well as the pivot of the floor check, are offset to permit the door to be opened to a wide angle.

In (d) is shown a floor check for a double-swinging door. This check works on the same general principle as the floor check for the single-swinging door. Two springs and two cylinders are used, each being adjustable independently, so that provision can be made for any wind condition. Thus, owing to the rush of air on windy days, it requires a great deal of spring power to close the door after it has been opened inwardly, and very little checking to keep the door from closing rapidly, because the wind acts as a check. When the door is opened outward the wind tends to close the door, so that very little spring power is required, but a great deal of checking resistance is required to keep the door from closing too rapidly. A double-swinging door is hung at the middle of the jamb with the check directly beneath it, so that the door swings equally to either side. Some forms of floor checks require a special hanging strip which is attached to the jamb, in order to set the hinge out from the jamb.

Double-acting floor hinges have the advantage over double-acting spring hinges attached to the jamb, in that the weight of the door is carried on the pivots, which generally are ball-bearing, and none of the weight of the door is carried on the springs.

A spring pivot, spring pivot hinge, or mortise floor hinge is shown in Fig. 19. The weight of the door is carried on a ball-bearing in the box, or case, let into the floor, as shown at *a*. This pivot is for a double-swinging door. In operating, this pivot not only closes the door, but prevents it, when closing, from oscillating after the door has reached its neutral, or closed, position. The top pivot is shown at *b*.

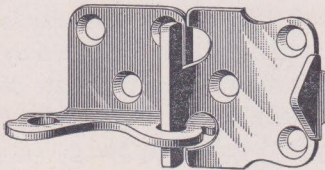

FIG. 20

Spring pivots are also designed with the entire mechanism attached to the door, a plate containing the bearing pivot being attached to the floor. Other types are designed to rest on the floor, and to be attached to the jamb, thus permitting the instal-

lation of a hinge or pivot without cutting into the finished floor.

Floor pivots are made also without springs, the door being closed by hand. These pivots permit the door to stand open at any position. They may be obtained for either single- or double-swinging doors, and are used principally on interior doors.

31. Outside Blind and Shutter Hinges.—The outside shutter, or blind, is still much used in the construction of dwelling houses, and a great variety of hardware is made to use in conjunction with hanging these devices. Only the most common of the many available types of this kind of hardware, however, will be treated here.

A type of the gravity-locking hinge is illustrated in Fig. 20. This hinge is made entirely of steel, and is commonly known as a gravity blind hinge. There is only one size of this hinge manufactured, and it is used for frame buildings. All of its

parts are interchangeable and reversible, so that it may be used for either right- or left-hand blinds. For frame and brick buildings, there is made a wrought-steel hinge, which obtains

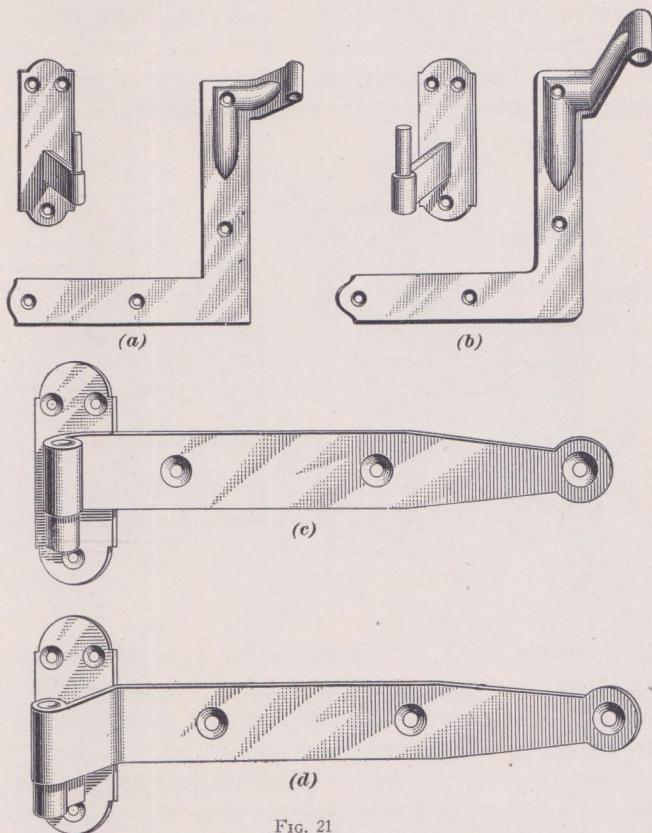

FIG. 21

a great purchase on the shutter. This hinge is illustrated in Fig. 21; the hinge shown in (a) is for frame buildings, while that shown in (b) is arranged for brick walls. The hinge in (b) is long enough to allow the blind to pass a 4-inch reveal.

Another type of hinge made entirely of wrought steel, used where great strength is required, is shown in (c) and (d). This type of hinge has a long strap that extends on the top and the bottom rail of the shutter and thus tends to prevent the blind

from drooping. This strap also strengthens the shutter by relieving the mortise and tenon of the rail and stile from the strain. This type of blind hinge is made in two styles. The hinge shown in (c) is intended for frame buildings, while that in (d) is made with an offset to throw the shutter clear of a brick jamb. These hinges are ordinarily used with blind adjusters, or fasteners, and for very high blinds, a center, or auxiliary, hinge is used.

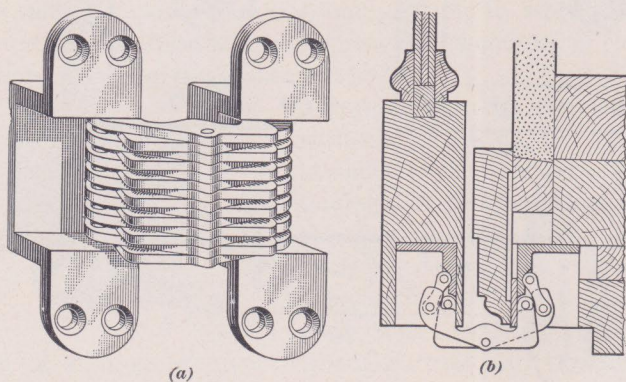

FIG. 22

32. Invisible Butts, or Hinges.—One type of invisible or secret hinge, known as the Soss hinge is shown in Fig. 22. This hinge, as shown in (a), consists of a number of plates supported on boxlike leaves which are let into the jamb, and also into the stile of the door. These plates fold into the box leaves, the entire hinge being invisible when the door is closed. These hinges are made in a variety of styles, the one shown being suitable for ordinary residence doors, when the doors are to be opened flat against the wall of the room, as shown in (b), and the projection of the base or trim does not extend more than $\frac{7}{8}$ inch beyond the face of the plaster or of the door in a closed position. As the hinges are made without removable pins, they can be used in horizontal as well as vertical positions. They are useful, therefore for such millwork as seats, secret jambs and panels, drop or folding leaves, and other

places where the hinge or joint is to be made invisible, or as inconspicuous as possible.

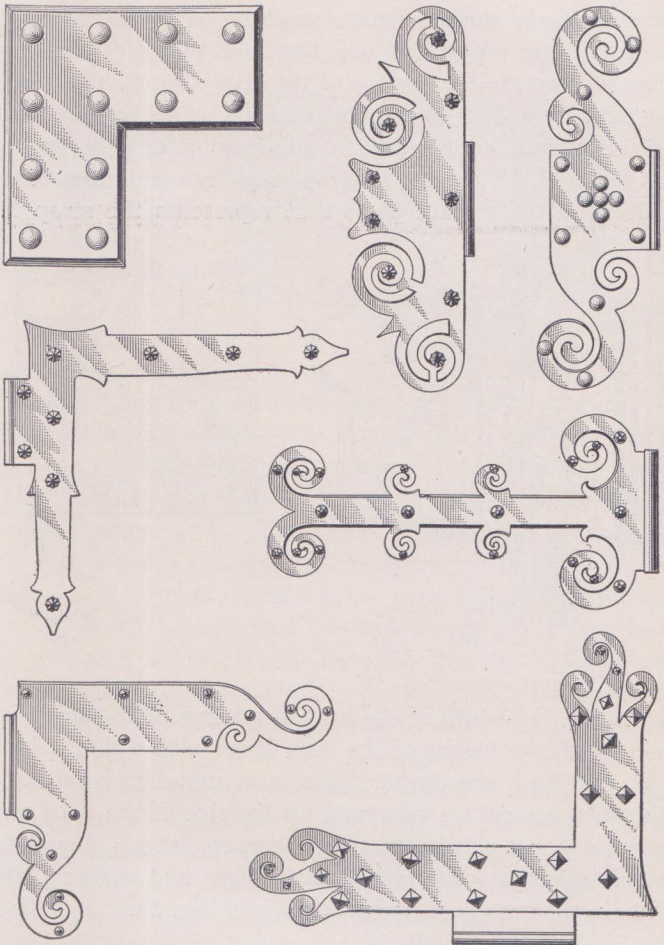

FIG. 23

33. Strap and Corner Hinge Plates.—Medieval hardware was the product of the blacksmith and the whitesmith, the former working with forge and hammer, and the latter with chisel and file, the material being wrought iron. The butt

hinge was unknown, while the strap, or surface, hinge was in universal use; and, as this was wholly in sight, it naturally became the subject of decoration, chiefly in outline, but occasionally in surface ornament also. With the adoption of the butt hinge for general use, the opportunity of utilizing the hinge to decorate the surface of the door disappeared, but with the modern revival of decorative art the use of constructive metal work as a feature of surface decoration for important doors was restored. This was accomplished by combining with the modern butt a surface plate that represents the strap hinge.

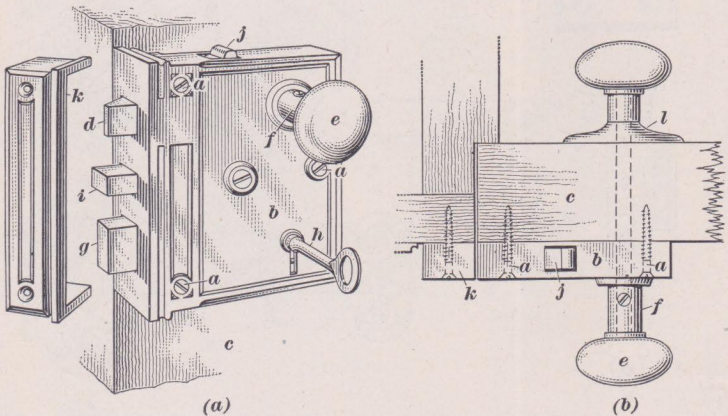

FIG. 24

Obviously, the width of the butt of a hinge plate should correspond with the height of the butt hinge with which it is to be used, and both should be of the same metal and finish. The other dimensions are governed by the size of the door and by taste, as is true also in the case of corner plates. A varied and artistic selection of typical strap hinges and corner plates is given in the groups of designs shown in Fig. 23.

LOCKS AND THEIR APPURTENANCES

34. Locks in General.—In no other line of hardware is there such a variety of grades and types as there is in door locks. Locks are designated as surface, or rim, locks, and mortise locks, the former being secured to the surface of the door and

entirely exposed to view, while the latter are let into a mortise cut in the edge of the stile.

These two types of locks are divided into two main classes, lever tumbler locks and cylinder locks, which will be described later.

35. Rim Locks.—A rim lock is one that is placed against the face of a door and screwed in place. In Fig. 24 is shown one type of rim lock. In (a) is a side view of the lock, and in (b) is a plan.

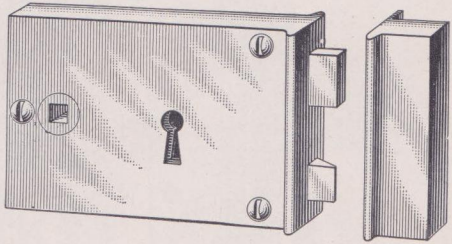

FIG. 25

The screws holding the lock to the door are shown at *a* in (a). The lock case is shown at *b*, and the door at *c*. A spring latch *d* is operated by the knob *e* and spindle *f*; a dead bolt *g* is controlled by a key *h*; a slide bolt *i* is operated by the thumb bolt *j*; a keeper is shown at *k*. The keeper is applied to the face of the trim as shown in the plan (b), in which the same reference letters are used as in (a) for the same parts. A rose is shown in (b) at *l*. It will be seen that this lock can be easily removed by the use of a screwdriver. The rim lock must therefore always be applied to the inside face of the door. The mortise lock, which is let into the stile of the door, is evidently a better device.

The rim lock shown in (a) is what is called an upright lock, because the knob is directly over the key. In Fig. 25 is shown a horizontal rim lock in which the key and knob are at the same horizontal level. In this example the bolt is operated by a key and the latch is operated by a knob.

Rim locks are used on account of their low cost and because they are easily applied.

Rim locks are generally constructed of cast iron and, in selecting them, a careful inspection should be made of their internal mechanism, so that only those in which the bolts and the tumblers are constructed of steel or brass will be chosen.

Rim locks, however, are also made of all steel, brass, or bronze. They present a somewhat better appearance than cast-iron locks, as may be seen from Fig. 26.

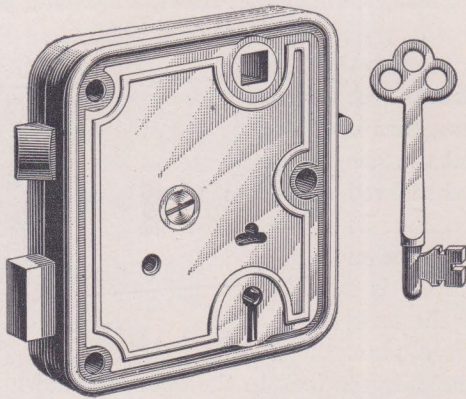

FIG. 26

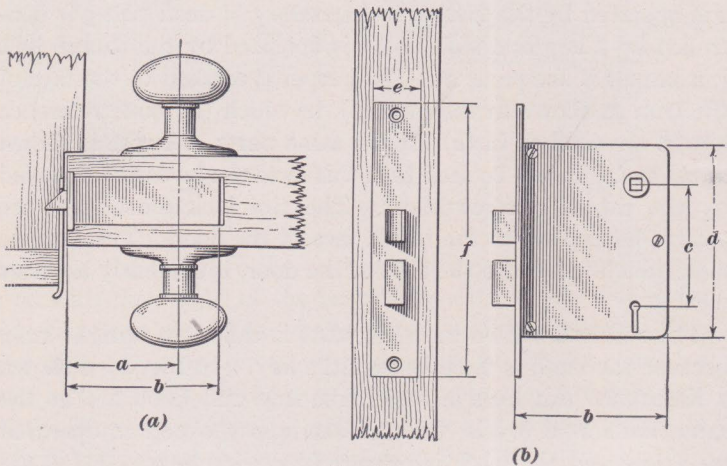

FIG. 27

36. Mortise Locks.—Mortise locks are let into the thickness of the door as shown in Fig. 27 (a), where the rectangular portion let into the stile of the door represents the lock. In (b) is shown a diagram of a mortise lock and its face. The standard dimensions used in describing locks are shown in this illustration

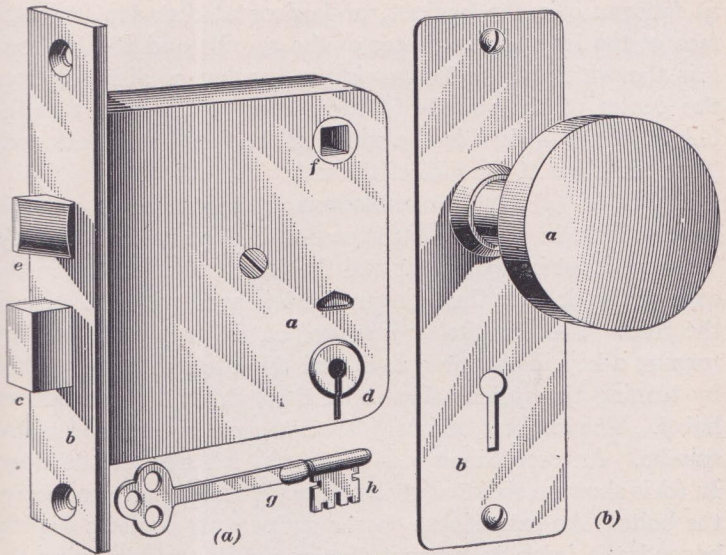

FIG. 28

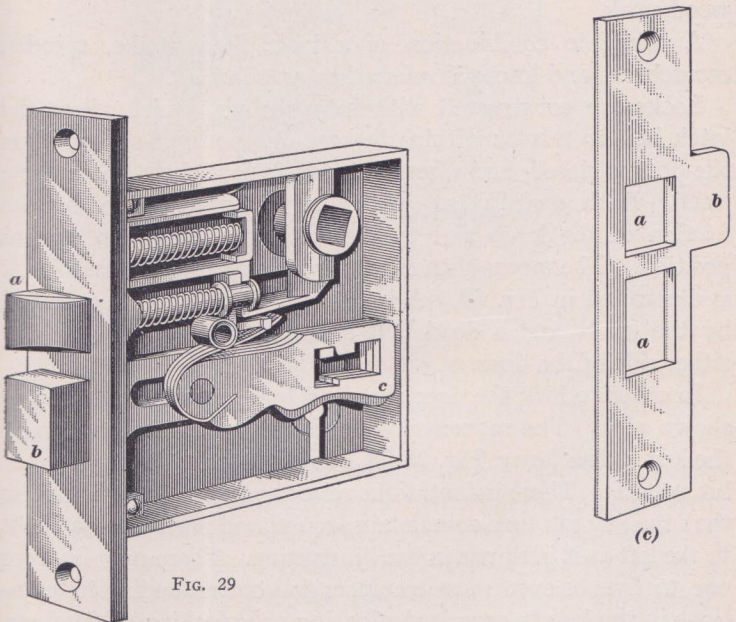

FIG. 29

as follows: a is the backset, or horizontal distance from the face of the lock to the center of the spindle and the keyhole; b is the width of the lock; c is the spacing or distance from the center of the spindle to the center of the key; d is the height of the lock; e is the width of the face of the lock, and f is the height of the face of the lock.

In Fig. 28 (a) is shown the outward appearance of a simple mortise lock, in which a is the case and b the face of the lock. The case is let into the door and the face is countersunk in the edge of the door so that the surface b is even with the edge of the door. The dead bolt c is moved out of or into the lock by turning a key in the keyhole d , and the latch bolt e is worked by turning the spindle that is let through the square hole or hub f . The knobs a , as in (b), are attached to each end of the spindle. An escutcheon b is fitted to each side of the door. In (c) is shown a strike or strike plate with openings a to receive the bolts. An extension b on the strike plate projects slightly beyond the jamb to prevent the latch bolt from marring the wood-work.

A complete combination of a lock, face, strike, spindle, escutcheon, and knobs is referred to as a *lock set*.

Locks are constructed with easy springs, which allow the latch bolt to retreat within the case on one light spring when the door is closed, and when the knob is turned, to operate the latch. Both springs act jointly in order to overcome the friction of the knob and to throw the bolt back to normal position. The mechanism of an easy-spring, mortise knob lock is illustrated in Fig. 29. A latch, or latch bolt, a is operated by the knob, and a dead bolt b is operated by a key, from either side of the door.

In order to lock the door the dead bolt must be extended as shown at b . The movement of the bolt is caused by turning the key. The key g , Fig. 28 (a), has indentations in its edge, or bit, as at h . These indentations raise the tumblers c , Fig. 29, so that the key can turn completely around and push the dead bolt to the left as it is shown in the illustration. There may be from one to five or even more tumblers and corresponding indentations in the key to permit the locking or unlocking of the door.

37. **Master-Keyed Locks.**—The type of lock known as the master-keyed lock is generally used for public or office buildings, hotels, and occasionally in the better class of residence

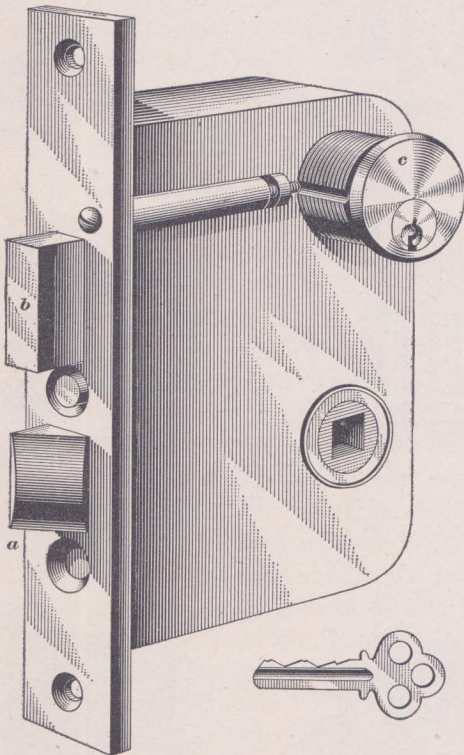

FIG. 30

work. These locks can be grouped into two classes, namely, the cylinder, and the lever-tumbler types, the first mentioned being the more desirable.

In the lever-tumbler type, illustrated in Fig. 29, the tumblers and wards are so arranged that each lock can be operated only by its particular key, the keys for all rooms being different and non-changeable; all of the locks, however, can be operated by a key made for the purpose, and termed a master key. Each lock of this type has two sets of tumblers; one set is operated

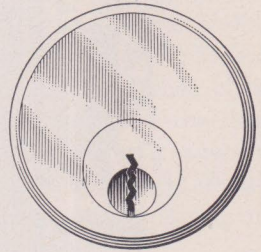
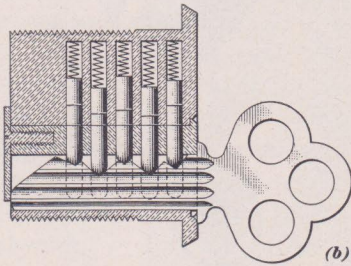
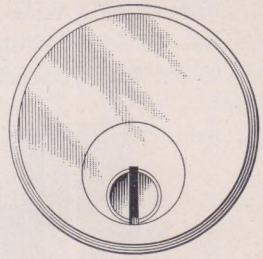
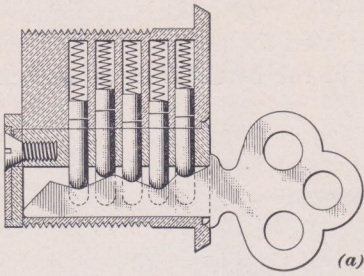

FIG. 31

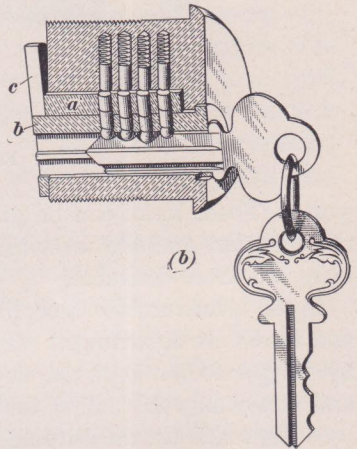
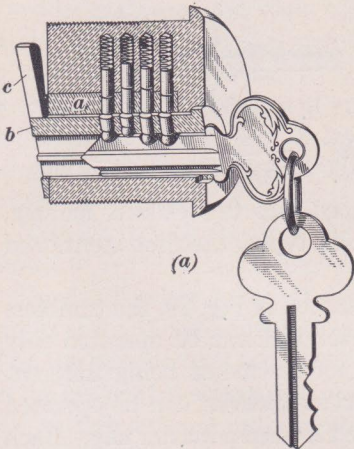

FIG. 32

by its individual key, and the other, being uniform in all locks of the series, is acted on by the master key. Such locks may be obtained either in the cheaper kind, with one tumbler and twelve changes, or in the most intricate styles of hotel locks, with five tumblers and 48,000 changes in one set, and all operated by one master key. The cylinder lock of this type is illustrated in Fig. 30, which shows a Yale & Towne mortise front-door lock.

38. Details of the Yale Type of Master-Key Locks.—The Yale type of cylinder lock, which is illustrated in Fig. 31 (*a*) and (*b*), is much preferred, on account of the great security it gives and the small key required by it. This lock is made in two systems, namely, the regular and the concentric.

In the regular system, one regular cylinder is controlled by the change and master keys, the pin tumblers being cut in two places, so that the change key brings one set of the abutting planes of the tumbler in alinement with the surface of the cylindrical plug. This plug is arranged so that a separate key is required to operate each lock, the other line of cleavage through the blocks being the same with all locks throughout the series, so that they may be opened with the same key.

The concentric cylindrical arrangement of this type of lock is shown in Fig. 32 (*a*) and (*b*). Here there is a larger cylinder encircling the key plug. This is known as the master-ring, or larger, plug, and is indicated at *a*. When the change key is inserted in the key plug *b*, the lower series of breaks in the pins comes into alinement with the outer edge of the plug, as shown in (*a*), and allows it to revolve in the master ring, the cam on the inner side at *c* actuating the lock. When the master key is inserted, the upper series of breaks comes into alinement with the outer edge of the master ring, as shown in (*b*), allowing the plug and the ring to rotate together with the turning of the key, and thus to produce the same result as that caused by the operation of the change key.

Owners or officials of large office buildings and industrial works now avail themselves of the master-key system just explained. They are able to obtain mortise locks, rim locks,

and padlocks, all arranged to operate with a master key, in one series. In fine residence work, this system is also adopted. Such a system of locking is easily recognized as convenient,

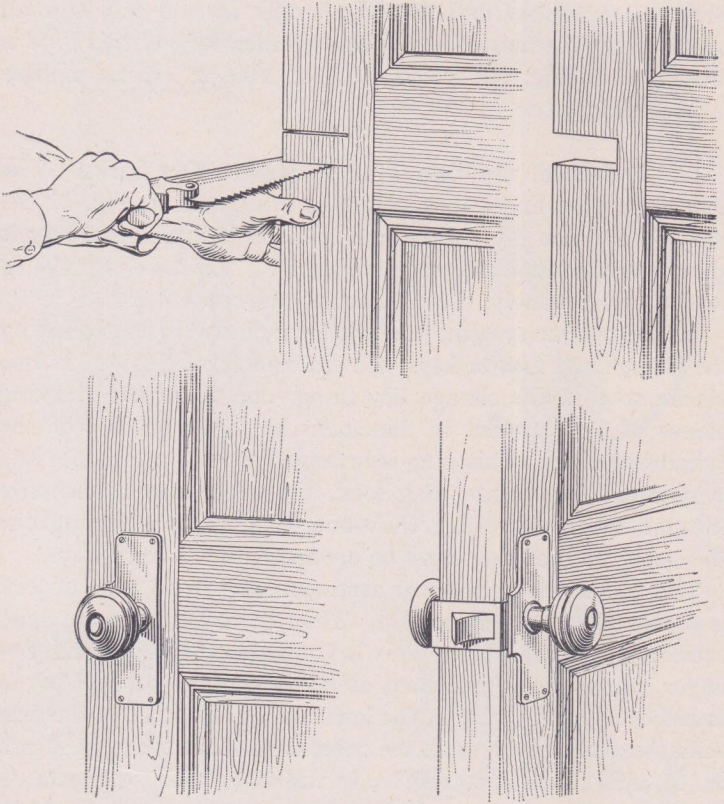

FIG. 33

especially where subordinates are held responsible for certain rooms or departments to which they, individually, have access, as all of the rooms or departments may be entered by the manager or superintendent by the aid of the master key.

A series of master-key locks may also be submaster-keyed by dividing it into subordinate groups. In such a case, each group is operated by a master key of its own, and all the sub-

ordinate groups are controlled by a grand master key. For example, a six-story office building could be furnished throughout with locks having non-changeable keys; the doors of each floor could be operated separately by a master key; and the doors of the entire building could be operated by a grand master key. The convenience of such a system is readily apparent in large buildings where each janitor is responsible for a certain floor, and where the head janitor, manager, or owner, has control of all the locks through the grand master key.

In some instances, for additional security and for special work, the corrugations in the keyway are changed in shape so that the manufacturers' regular type of key will not enter the keyway, or plug, thus allowing no chance for the regular type of key to operate the lock.

Cylinders, either plain or master-key, may be used in either rim or mortise locks. Similar locks may be applied to cupboards, closets, drawers, etc., where a high degree of protection is desired.

39. Unit Cylinder Lock.—The unit-cylinder lock, illustrated in Fig. 33, is made by P. & F. Corbin. This hardware specialty is a very useful device in lock making. The mechanism of the lock is contracted into the smallest possible space, occupying only about $1\frac{1}{2}$ in. \times $3\frac{1}{4}$ in. Instead of being mortised into the stile of the door, as is usual with the mortise lock, a piece is cut entirely from the stile, as illustrated. In order to prevent this operation from weakening the stile of the door, the unit-cylinder lock is provided with heavy escutcheon plates that are strongly ribbed on the back, so that, when these plates are secured to the stile at the top and bottom, they supply the rigidity necessary to make up for the notching. As the name implies, these locks are made in a unit, and the keyhole to the cylinder lock is located in the knob. The unit-cylinder lock is made in two styles—with dead-locking latch bolt and with additional dead bolt.

40. Unit Locks.—The type of unit lock shown in Fig. 34 contains several novel features. The case *a* is cylindrical and is assembled with the outside knob *b*, a cylinder lock being

built into the outside knob. The inside knob *c* contains a button *d* in the center. Pushing this button locks the door, so that a key is required to operate the lock from the outside. The door may be opened from the inside at any time by turning the knob.

To install this lock, a $2\frac{1}{8}$ -inch hole is bored through the door to take the case. A 1-inch hole is bored in the edge to take the bolt case *e*, and a mortise is cut for the face-plate *f*.

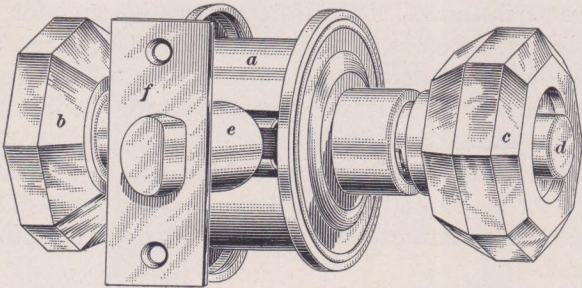

FIG. 34

This type of lock can be master-keyed, is adjustable for doors from $1\frac{3}{8}$ to 2 inches, and can be had with either the regular bevel for the face-plate, or the plate may be rabbeted. Various styles are made for different purposes, such as for outside doors, inside doors, communicating doors, bathroom doors, closet doors, etc.

41. Locks for Residence Use.—The front-door lock is distinctly a lock having two bolts; namely, a dead bolt and a latch bolt. The latter is operated by the knob and is so arranged that, by means of stop-work in the lock front, the outer knob may, at will, be set so as not to operate the latch, the latch bolt being operated only from the outside by a key.

The cylinder type of front-door lock illustrated in Fig. 30 is the best lock for this purpose, as it provides the greatest security. This lock is operated by a convenient key of the Yale type, which throws both the latch *a* and the dead bolt *b* with one insertion of the key into the cylinder.

Three-tumbler, front-door locks and latches are to be had at a low cost, and are used in the cheaper class of dwellings. When the residence has an inner, or vestibule, door, a similar lock is used without the dead bolt; this lock is termed a vestibule latch. In all cases the vestibule lock should "key-lock" with the front-door lock, so that one key will operate both.

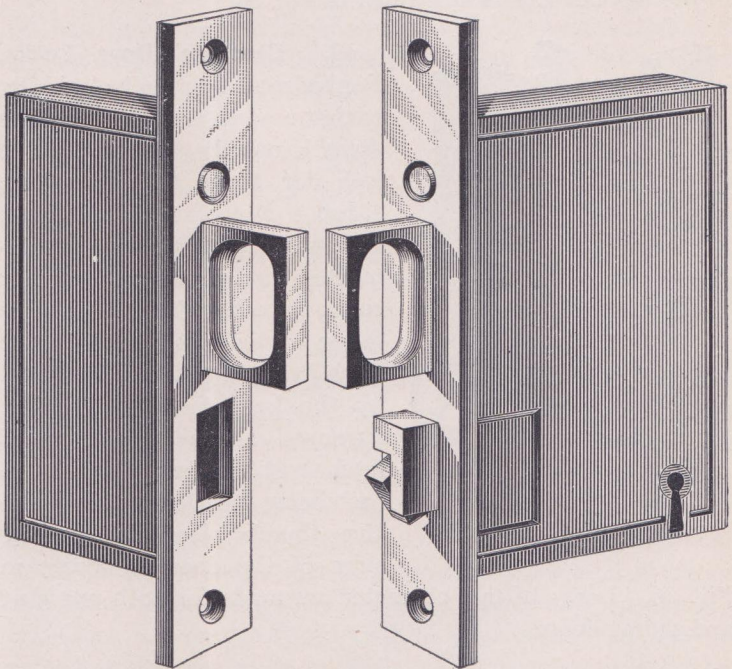

FIG. 35

The other exterior doors of a residence should have either locks master-keyed to the front door, for the better class of work, or locks of the 5-inch, three-bolt variety, that are furnished with an extra bolt in addition to the dead bolt, the third bolt being operated by a thumb knob on the inside. When a cheaper trim is wanted, a 4-inch, two-bolt lock, supplemented by a separate mortise or rim bolt, may be used. This bolt may be operated by a key from the outside, or by a thumb knob on the inside. This bolt provides additional security.

42. Sliding Door Locks.—For the first- or parlor-floor folding doors, 4- or 4½-inch, two-bolt, mortise locks are ordinarily employed. Where the doors are sliding, a 5½-inch, sliding-door lock with dead bolt and pull, or handle, is provided. The pull, or handle, is operated, or thrown out, when needed by pushing a button, or stop, in the lock. This special type of sliding-door lock is illustrated in Fig. 35.

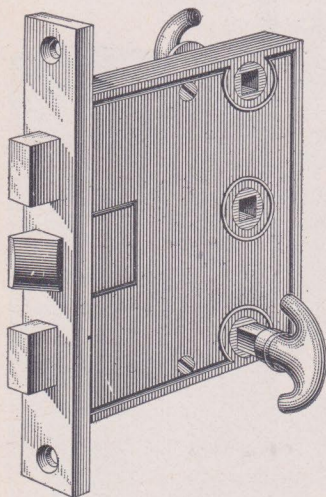

FIG. 36

Fig. 36. Locks of this character are made for both swinging and sliding doors.

44. Closet-Door Locks.—In fitting closet doors, it is best to use a two-bolt lock about 4 inches in size, with trim on both sides, so that the door may be operated from inside in case it is accidentally closed on a person in the closet. The possibility of this happening is slight, and usually a saving is effected by using a knob latch without a dead bolt and a pair of knobs with roses.

45. Basement and Attic-Door Locks.—For basement or attic doors, a cheap type of mortise lock is appropriate, or a rim lock may be used, if cost is a consideration. Where care

43. Bedroom Door Locks.

For bedroom doors, a lock similar to that used on the minor exterior doors is usually employed. The lock for these doors may be either a 5-inch, three-bolt lock, or a 4-inch two-bolt lock supplemented with a mortise bolt. For communicating doors, it is best to use a three-bolt, knob lock, the latch bolt of which is operated by the knob from either side. Arranged above or below this latch bolt are two dead bolts, each being operated by its respective thumb piece on opposite sides of the door as shown in

is exercised in the selection of locks in any one building, great convenience will result from having all the different classes of locks about the building of the same grade, so that they may be master-keyed in one set and thus give the owner control, with one key, of all the locks. Each lock, however, will have its own individual, or change, key, and should be selected and ordered with this object in view. Another convenience may be had by ordering each room and closet door keyed alike throughout the house, or alike throughout each floor, so that the loss of a key will cause little or no inconvenience.

46. Hotel and Office Locks.—The purpose and use of master-keyed locks has already been explained, but the employment of such locks in large groups, as in the equipment of hotels and office buildings, requires further discussion. The term corridor door designates the entrance from a corridor or a hallway to a bedroom or an office, while communicating doors are those between adjoining rooms. Frequently, these doors are double, and are then known as twin doors, while the term closet doors is self-explanatory. Each of these doors requires a knob lock, that is, a lock having the latch bolt operated by the knob and the dead bolt operated by a key. Sometimes, in the case of locks on closet doors, the dead bolt on communicating-door locks is omitted, and a thumb bolt substituted. While all of the locks thus far enumerated are used in hotels, and most of them in office buildings, technically speaking, a hotel lock is a master-keyed knob lock for doors from the corridor to bedrooms, while an office lock is an inverted lock; that is, a lock with the keyhole above the knob. These latter locks are usually master-keyed, especially for the doors from the corridor to the office. Such locks as these may be master-keyed on any of the systems, as previously explained. For office work, a small key is desirable, so that cylinder locks are ordinarily employed, as the key for the operation of such locks may be conveniently carried. For hotels, however, a high-grade lever-tumbler lock with round, substantial keys is desirable, because the keys are liable to hard usage, and should not be convenient to carry in the pocket.

Hotel locks vary widely in arrangement, as well as in size, quality, and price. The kind of action, or mechanism, to be adopted in a hotel lock is frequently determined by the preference and experience of the hotel manager, and it is desirable that he should be consulted in advance; but the location and use of each door should be considered in the selection of the locks for this character of building. It will thus be seen that the subject of hardware for a hotel is one that requires the most careful consideration of the architect.

The grouping of locks in a hotel should be studied, and usually, the best plan in large hotels is to group all of the locks on each floor under one master key and to provide a different master key for each floor, care being taken to limit the issue of master keys to the smallest possible number of responsible persons. In some cases, a grand master key is also provided that will open all the locks on every floor. This arrangement of the locks entails an additional expense, and also has the disadvantage that, in case the grand master key is lost, all of the locks controlled by it should at once be set to a new combination, in order to prevent access by the person into whose hands the key has fallen. This procedure is both troublesome and expensive.

The foregoing remarks relating to hotel locks apply equally to office locks, especially as to the arrangement for the operation with the master key. In other respects, however, the locks for an office building differ considerably from those used in hotels, for a hotel lock must secure the door both when the room is occupied and when it is not, whereas an office lock is used chiefly to secure it when not occupied. In consequence of this, certain differences in action are employed. All office locks have a latch bolt that is operated by the knob from both sides and yet permits free ingress and egress. Various methods, however, are employed to lock the door against ingress except by means of a key. Sometimes this is accomplished by means of a separate dead bolt operated by a master key from either side; in other cases it is accomplished by a latch bolt only, by providing the latter with a stop-work like a front-door lock. By this arrangement, the outer knob may be stopped so that

the latch bolt cannot be operated from the exterior except by the key; and, again, the latch bolt may be dead-locked from the outside by the key. The choice of these arrangements is a matter of personal preference.

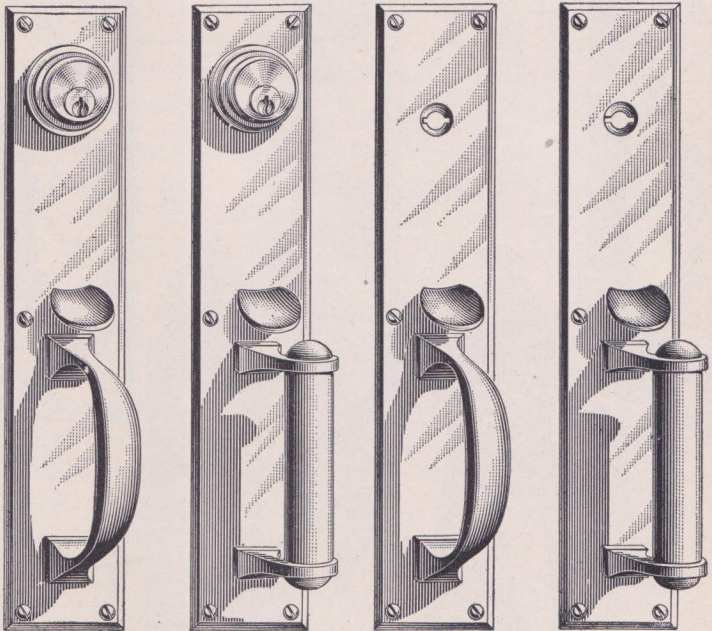

FIG. 37

47. Store-Door Locks and Trim.—The technical term store-door lock originally designated a heavy rim or mortise dead lock, but is now applied to a combined lock and latch, the former being operated by a key from either side, and the latter by a thumb piece located above the pull handle. Such locks are made in a large variety of sizes and styles, the best being of the cylinder type, as shown in Fig. 37. In this lock, the latch is operated by the thumb piece during the day, while the dead latch secures the door at night.

Plates and handles for the combined store-door lock and latch are also made in many sizes and styles, from the plain

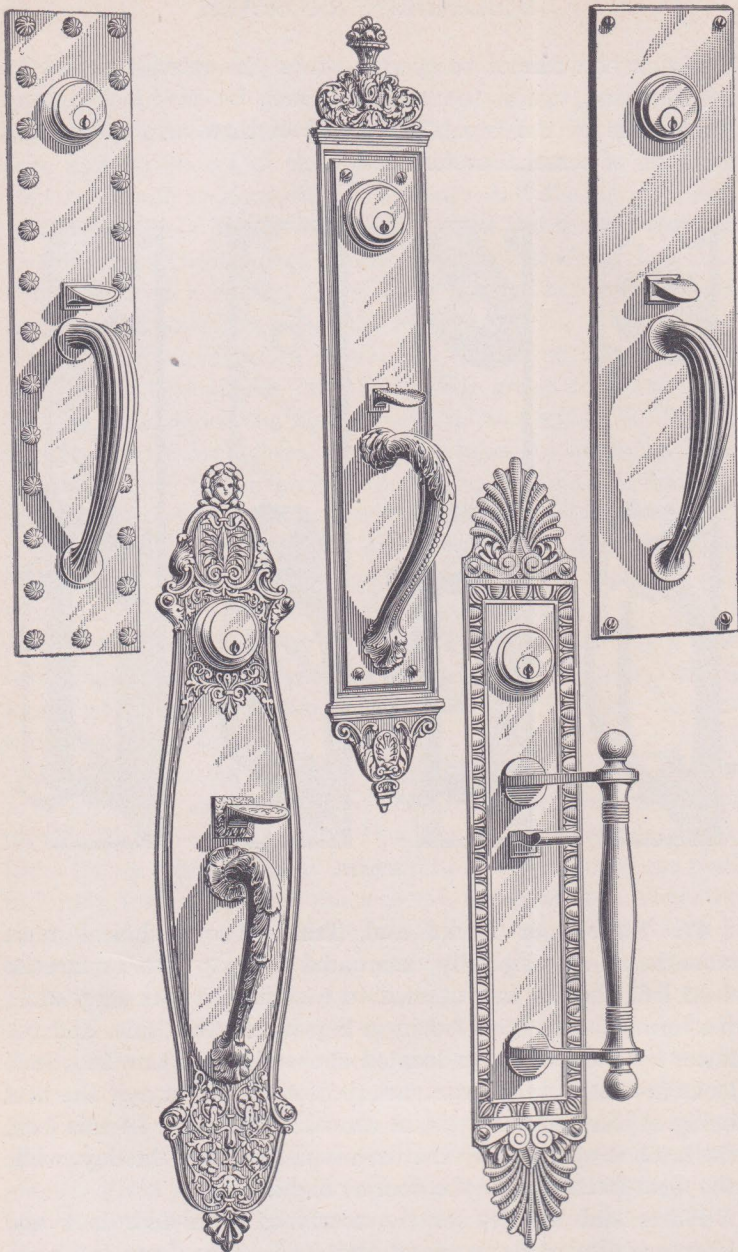

FIG. 38

Original from the E.R. Butler & Co. Research Library

rectangular type to the most ornamental forms. Such trim offers good opportunity for effective decoration, and no embellishment is so effective for a store's entrance door as a pair of handsome plates and handles of appropriate design.

Some of the more elaborate store-door handles are illustrated in Fig. 38. The trim illustrated in these plates is very carefully selected by the architect to match the style of architecture in which the building is designed, and the finish is selected with as much care.

48. Padlocks.—While padlocks are not ordinarily included in builders' hardware, they are extensively used for factories, stables, and other buildings of this character; thus some care should be taken in their selection. Padlocks are made in a great variety of sizes, styles, and qualities. Where these locks are exposed to moisture or to the weather, they should be of bronze or of brass, with all of the interior construction of the same material. If required for great security, that is, for places where they are likely to be subjected to violence, they should be very heavy and provided with steel shackles. Padlocks constructed on the cylinder-lock principle may be obtained, and should always be used, where a series of locks that are operated by separate keys and controlled by a master key is employed. Ordinarily, a selection of padlocks should be made only after an inspection of the actual samples, and not according to catalog representations.

49. Cabinet Locks.—The locks used in cabinetwork are distinct from builders' locks, though they are occasionally used in the construction of the finer classes of interior finish, and, consequently, are of interest to the architect. Cabinet locks are made chiefly of wrought metal, and in a vast variety of kinds, sizes, and grades, so that care should be exercised in their selection. The leading kind of cabinet locks are drawer, or till, locks; wardrobe, or cupboard, locks; and chest, box, and desk locks. Special locks are also manufactured for many other purposes. For the best work, the Yale, or pin-tumbler, type is desirable where great security is required, but for ordinary uses, other types, with either flat or round keys, are

available. Many of the cabinet locks admit of being master-keyed, and such locks are employed on lockers in club rooms, armories, etc.

50. Care and Maintenance of Locks.—Locks, like other pieces of mechanism, need reasonable care and attention to keep them in the best condition. As they contain moving parts, they are subjected to frictional wear and need occasional lubrication. Most of the friction, and consequently the wear, occurs in the beveled latch bolt, which may be readily lubricated. If the latch bolt is troublesome, its face and back should be cleaned with a cloth moistened with naphtha or kerosene, to remove any dirt. These surfaces should then be wiped with another cloth saturated with machine oil, or, better, with vaseline. Any person can perform this simple work, and if it is done once or twice a year, it will keep the bolts in such condition that each door will close easily and quietly at all times. Another cause of trouble is the tendency of the old-fashioned knob screw to become loose, thus allowing the knob to pull from the spindle. Where such spindles are used, it is a good plan to inspect them occasionally and to tighten any loose screws. The best results from lock hardware, however, can be obtained by having all locks and hardware inspected by a lock expert about once a year.

51. Pottery Knobs.—Door knobs, which are important appurtenances to locks and latches, are made of many kinds of materials, and are fastened to the spindle in several ways. The cheapest type of door knob is molded from clay. These pottery knobs are secured to iron or bronze shanks by leading; that is, by setting them in molten lead, which, in hardening, secures the knob to the shank.

Pottery knobs are made in three styles, namely, mineral, jet, and porcelain. Mineral knobs are dark in color, while jet and porcelain knobs are, respectively, jet black and pure white. All of these knobs are highly glazed. Ordinarily, they are furnished with japanned mountings, or shank and rose; occasionally, however, they may be had with bronze-plated, real bronze, or brass mountings. Styles of porcelain knobs

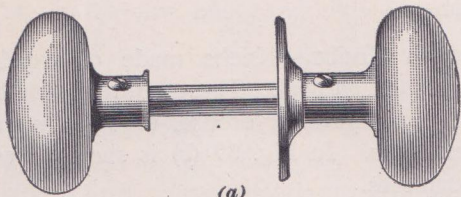

(a)

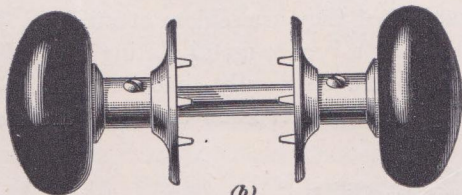

(b)

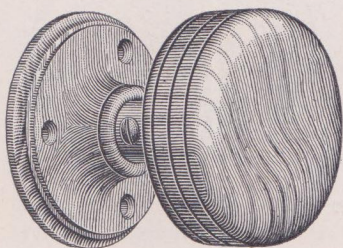

(c)



(d)



(e)

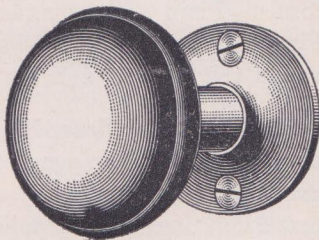

(f)

FIG. 39

are illustrated in Fig. 39 (a), and in (b) are styles of jet or pottery knobs.

52. Wooden Knobs.—Knobs made of wood are either stained or finished natural. The mountings for better knobs are made of iron, brass, or bronze, though they may be had with wooden roses. In Fig. 39 (c) is shown a wooden knob with a wooden rose.

53. Cast-Iron Knobs.—Knobs made of cast iron are strong and serviceable, but they are seldom attractive. For finishing knobs of this kind, a bronze metal plating is usually employed. Cast-iron knobs are frequently made ornamental instead of plain. A typical cast-iron knob and rose are shown in Fig. 39 (d).

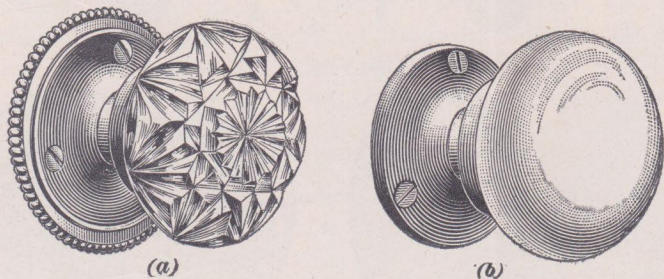

FIG. 40

54. Stamped and Spun-Metal Knobs.—Knobs made of sheet metal may be obtained in a large variety of designs and forms. Plain and ornamental steel knobs are illustrated in Fig. 39 (e) and (f). Knobs ornamented in any style of design are in the market, and are artistic and usually well modeled.

55. Bronze or Brass Knobs.—Knobs of bronze or brass are always used in buildings of the better class, and all ornamental knobs of the higher grade are made of these materials. The best knobs are usually solid; that is, cast in one piece, with the exception that the shank is inserted. Others are made in composite form, consisting of a steel interior shell, or frame, over which is tightly drawn an external section, or covering, of wrought bronze or brass of substantial thickness. The com-

pleted knob, if properly made in this manner, is practically as strong as the hollow-cast knob and resists bruising or other injury.

56. Glass Knobs.—Very expensive knobs are those of cut glass with metal mountings. Knobs of this kind are illustrated in Fig. 40 (a) and (b). Cut-glass or crystal-glass knobs are very costly, the price depending on the style and the amount of cutting required and on the grade of glass used. The new method of mounting glass knobs allows for adjusting the knobs to doors of varying thicknesses, and also gives the knobs a handsome appearance, making them both durable and reliable.

57. Styles and Sizes of Knobs.—The pottery knobs, such as the mineral, jet, and porcelain knobs, are made only in spheroidal and oval shapes. The spheroidal knobs are $2\frac{1}{4}$ inches in diameter, and the oval knobs $2\frac{1}{2}$ in. \times $1\frac{3}{4}$ in.

Cast-iron and stamped-steel knobs are made spheroidal and of the box pattern, with plain and molded edges, both styles of knobs being about $2\frac{1}{4}$ inches in diameter.

Bronze and brass knobs are usually spheroidal or ball-shaped, and are $2\frac{1}{4}$ and $2\frac{1}{2}$ inches in diameter. They are also made oval and egg-shaped, these latter styles being provided in two sizes, namely, 3 in. \times 2 in. and $2\frac{1}{2}$ in. \times $1\frac{3}{4}$ in. The same general dimensions obtain for wooden and glass knobs.

58. Lock Spindles.—In supplying a pair of knobs, there is always included with them the spindle, which connects them and passes through the hub of the lock. The type of spindle generally used is the common, or sidescrew, spindle, which is shown in Fig. 41 (a) and (b). In this spindle, the knobs are secured by means of a knob screw passing through a hole in the knob and engaging with one of the threaded holes in the spindle. There are several holes in the spindle, so that the distance the knobs are apart may be adjusted properly. Should further adjustment be required, it is accomplished by placing thin washers at the end of the knob shank. This type of spindle is generally used with the cheap grades of trim, and should not be used in high-grade work.

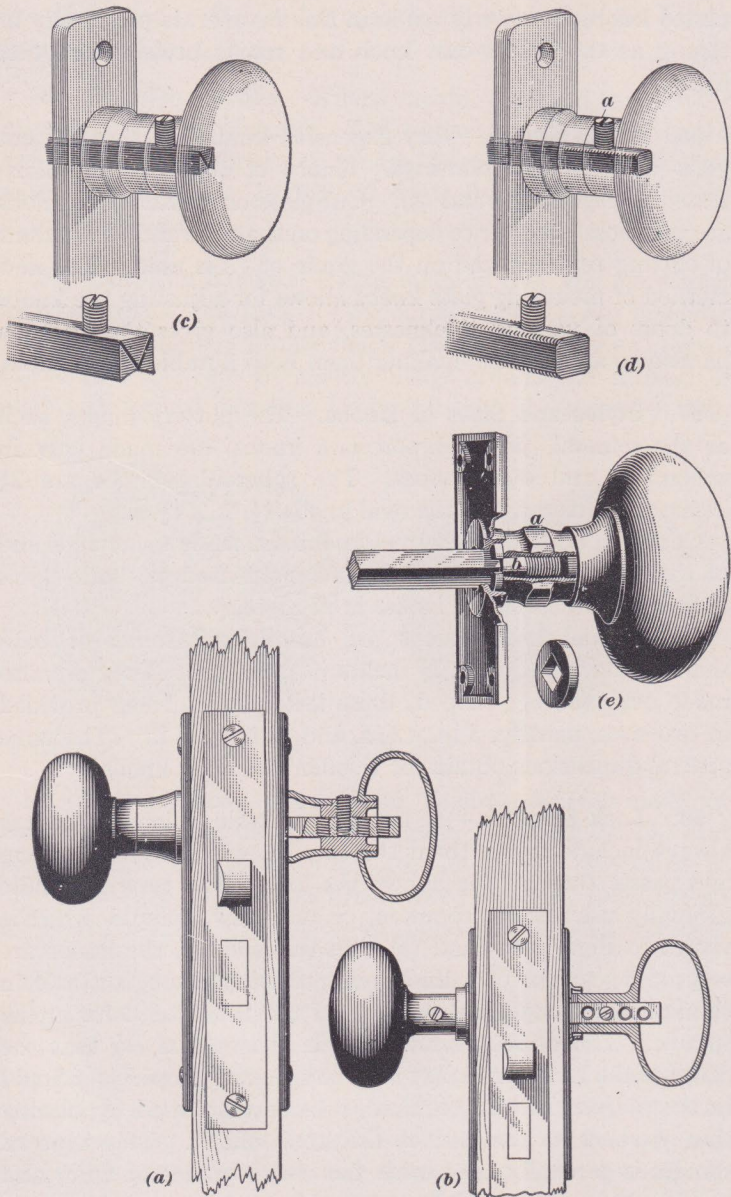

FIG. 41

59. Screwless Spindles.—There is a modern type of lock spindle, known as the screwless spindle, that permits the proper adjustment of the knobs without the use of washers. These spindles overcome the general looseness and rattle found in the common type. A screwless spindle, known as the Triplex, is illustrated in Fig. 41 (c). This spindle is a first-class device, and is constructed, as shown, of three parallel parts, triangular in section, which, together, form a square bar. To fasten the knob on this spindle, a setscrew in the knob bears on the center bar, and owing to their wedge form, the two side bars are forced apart and into frictional engagement with the spindle of the knob. The spindle itself is screwless, and there is nothing tending to loosen the setscrew, so that when once properly tightened, the knob will remain firm and in position on the spindle under all conditions of use. When the knobs are put in place as they should be, this device always gives entire satisfaction.

60. Threaded Spindles.—The threaded spindle is a solid square spindle that is threaded at the corners as shown in Fig. 41 (d). The knob is screwed to the spindle and the setscrew *a* is tightened, thus preventing the unscrewing of the knob. This arrangement provides a fine adjustment and is a very satisfactory device.

61. Wrench Spindles.—There is another, though somewhat costly, type of spindle in the market, known as the wrench spindle, which is illustrated in Fig. 41 (e). As shown, the mechanism consists of a chuck, or vise-like arrangement, formed on the knob shank. When the nut *a* is screwed on the jaws *b*, the tendency is to grip the spindle securely, the latter being solid and without screw holes. This type of spindle allows perfect adjustment.

62. Swivel Spindles.—Another type of knob spindle is the swivel spindle. This is used with front, vestibule, and other door locks that have stop-work, whereby the outside knob may be made operative or not, as desired. In order to accomplish this, the spindle is divided, so that one end may rotate independently of the other.

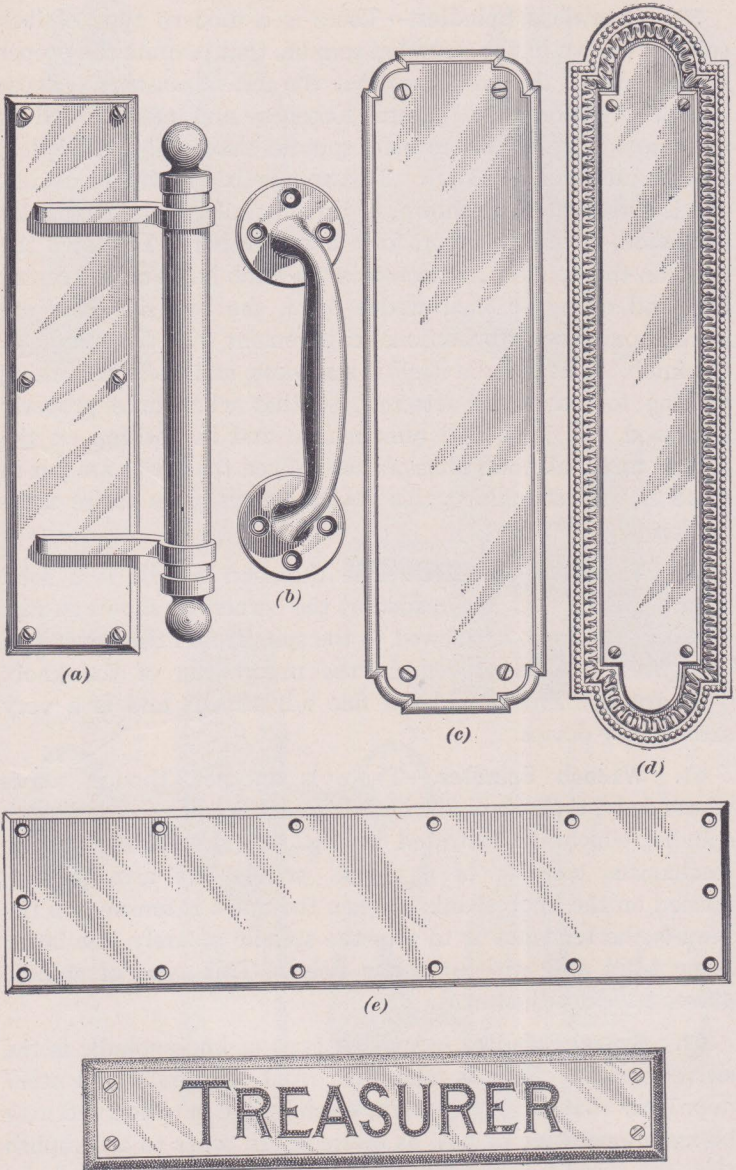

(f)
FIG. 42

The standard sizes of spindles for door locks, etc. are $\frac{5}{16}$ and $\frac{3}{8}$ inch square. Occasionally, spindles as large as $\frac{1}{2}$ inch square are used for large knobs or handles, such as would be used with massive lock trim. For thumb knobs and locks and latches of this character, spindles $\frac{1}{4}$ inch square are employed.

DOOR HARDWARE

63. Door Pulls.—In Fig. 42 (a) and (b) are illustrated two well-known types of door pulls. The pull shown at (a) consists of a handle that is usually mounted on a plate and attached to either storm or single-acting doors, although, occasionally, this type is used on double-acting doors with the word "push" or "pull" inscribed on the plate. When used on double-acting doors, the door pull has a tendency to obviate the habit of persons placing their hands on the moldings near the glass when operating the door, but is subject to the objection of inviting a pull to open the door even with the word "push" inscribed on the plate.

Door pulls are made in various metals, both in plain and ornamental design, some of the latter being very elaborate, as will be observed from Fig. 43.

64. Push Plates.—On double-acting or single-acting doors, such as storm and vestibule doors, push plates made of flat sheets of metal are used to protect the woodwork against soiling and wear from handling. These plates are made in various sizes, and are either plain or ornamented to harmonize with the other hardware. To obtain good results, push plates should be as wide as the lock stile, where possible, and from 12 to 30 inches long, according to conditions and use. Plates 20 inches or less in length should be placed on the door so that the distance from the floor to the center of the plate is about 4 feet 6 inches; for larger plates the distance from the floor to the top of the plate should be 5 feet. If used in connection with a cylinder deadlock, the plate should be cut or drilled, preferably near the bottom, to allow the cylinder of the lock to pass through the plate. The plain type of push plate is illustrated in Fig. 42 (c), while one of more ornamental design is shown in (d).

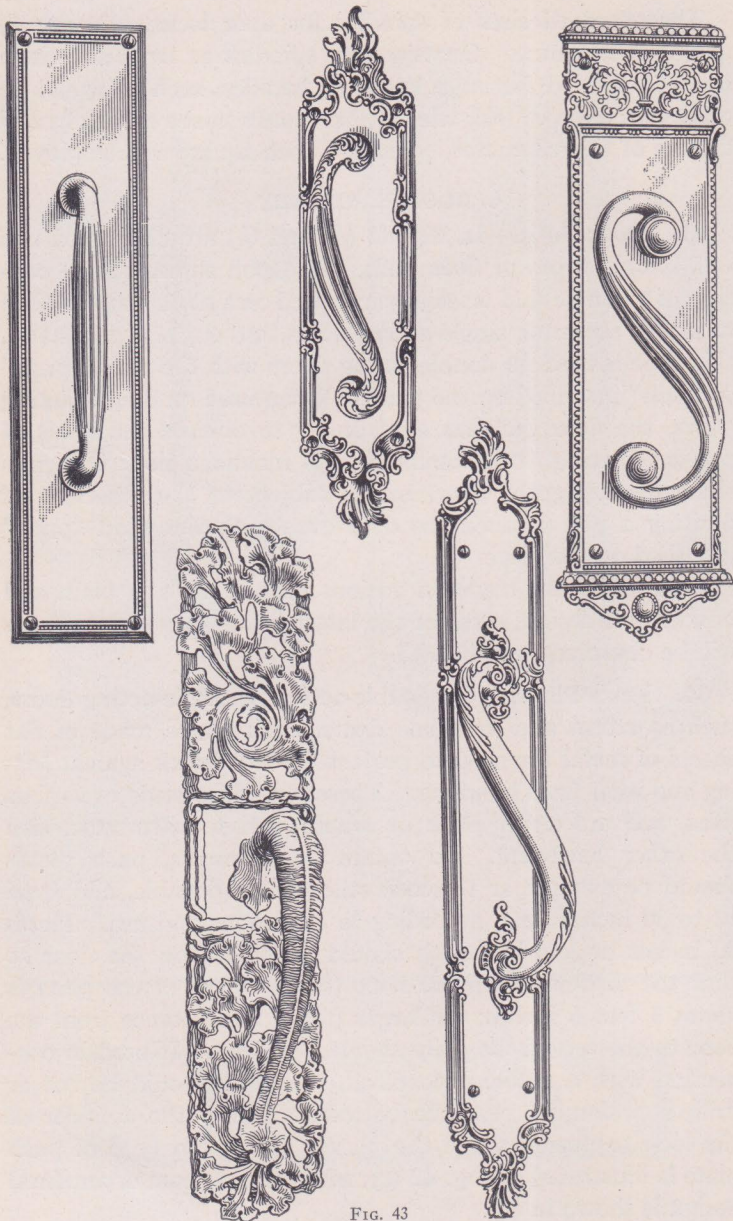

FIG. 43

65. Kick Plates.—A kick plate is a device that may be applied to the bottom of doors to protect the woodwork from injury and wear, being used chiefly for double-acting doors and doors of public buildings. These plates are frequently made of sheet metal, but are much handsomer when made of cast metal and ornamented to harmonize with other metal work of the door.

Kick plates should completely cover the bottom rail of the door, but if cost is the controlling factor, they may be cut down in height so that a margin of wood the same width as the side, or lock, stile shows above the plate. For instance, if the bottom rail is 12 inches in height and the stile is 5 inches wide, the kick plate should be 7 inches high. In all cases, kick plates should extend the full width of the door, allowing enough margin, when used on double-acting-doors, for the rounding of the edges. When used on single-acting doors having rabbeted jambs, the rabbet of both jambs should be deducted from the length of the kick plate. A typical kick plate of plain pattern is shown in Fig. 42 (e).

66. Sign Plates.—Although metallic plates with lettering are not usually included in the hardware specifications, they find extensive use in hotels, banks, and other public buildings. The inscriptions available cover every possible demand, including titles of officers, names of rooms, etc. Sign plates of various sizes can be procured in the following finishes: Bronze, brass, or nickel with either sunken or raised black letters; bronze or brass with black background or matte; white porcelain plate with blue, red, or gilt letters; and blue porcelain with white letters. A typical sign plate is shown in Fig. 42 (f).

67. Door Stops and Holders.—Since door checks and double-acting doors have come into use, the necessity of holding doors open has created a demand for door stops and holders. The door stop is a device for limiting the backward swing of a door. This device may also be constructed so as to perform the additional function of holding the door in an open position; it is then known as a door holder.

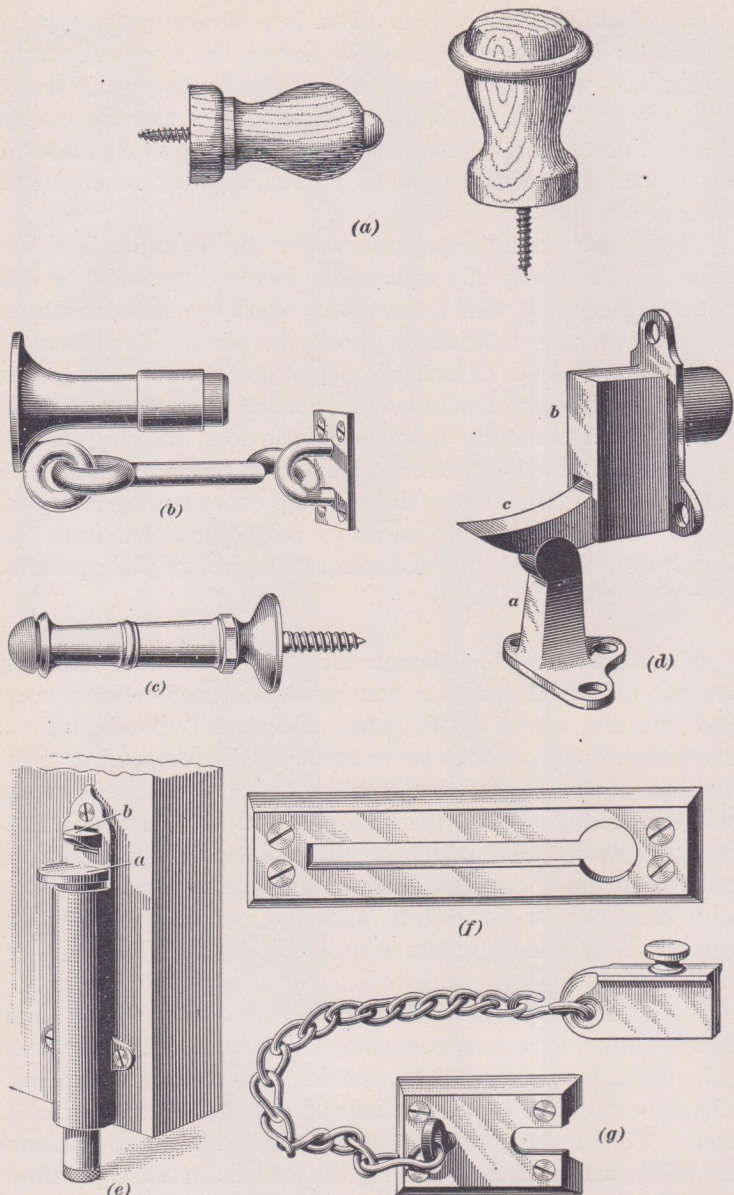

FIG. 44

The ordinary door stop is simply a wooden knob with rubber tip, or ring, that may be fastened to the floor or a baseboard, and is usually made up in the forms shown in Fig. 44 (*a*). Better grades made of iron or bronze are also available. These come in various shapes, as shown in (*b*) and (*c*). Frequently, as shown in (*b*), a hook for fastening the door in an open position is combined with the door stop.

The door stop with the hook holdback is not always convenient to use, so that the automatic holdback, or door holder, shown in (*d*) is sometimes employed. The lower part *a* of this device is screwed to the floor and the upper part *b* is fastened to the door. The part *c* is kept in the position shown by a spring. This holder can be disengaged by a pull on the handle of the door and automatically leaves the door in an entirely open position.

Where it is desired to hold a door in any position or to release it quickly, the rubber-tipped holder shown in (*e*) should be used; this device is fastened to the door and when the bolt *a* is pushed down, the rubber tip on the bolt is pressed against the floor and holds the door in place. It is easily operated and controlled by the foot. When the trip *b* is pressed down, a spring retracts the bolt.

68. Chain Door Fastener.—The type of chain fastener illustrated in Fig. 44 (*f*) and (*g*) is generally used on exterior residence doors. This device allows the occupants to open the door partly without permitting entrance. It consists of a heavy chain shown in (*g*) one end of which is attached to a plate, which in turn is fastened to the jamb with screws. The other end of the chain carries a knob or a hook that may be inserted in the slot of the long plate, shown in (*f*), which is attached to the door. By this means, the door may be opened only slightly. The door must be closed before the knob of the chain can be released from the slot.

69. Door Bolts.—Door bolts are made in all sizes, in wrought steel, cast iron, brass, and bronze, and may be procured in any finish desired. Several types of bolts used in common practice are illustrated in Fig. 45. In (*a*) is shown a type of barrel

bolt; in (b), is shown what is known as a cased bolt; and in (c) is shown a square-necked bolt.

70. Mortise Bolts.—In Fig. 46 (a) is shown a mortise dead-lock which has a dead bolt *a* that is operated by the turn knob *b*. This device is let into the edge of the door in the same way as a mortise lock. In (b) is a cylinder mortise deadlock which may have cylinders on both sides, or may have a cylinder on one side and a turn knob on the other.

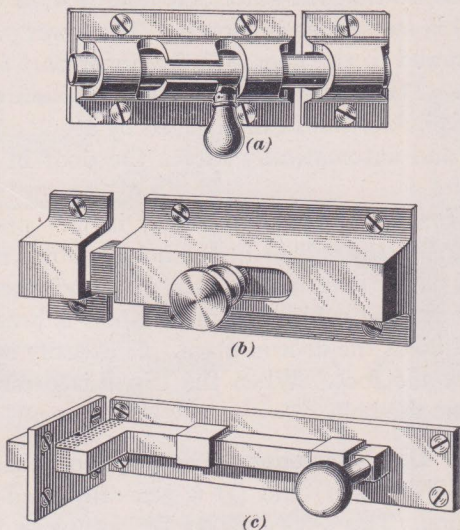
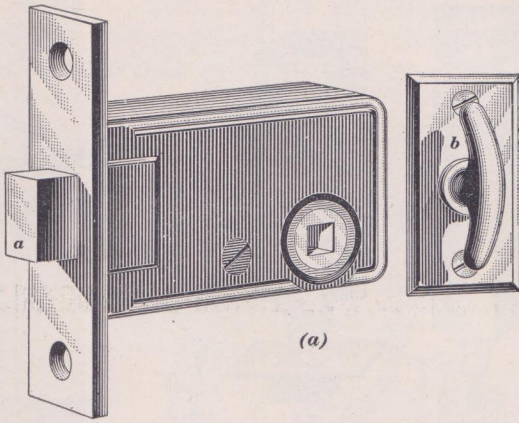

FIG. 45

In (c) is a mortise spring lock, which may be operated by cylinders and keys only, or by a turn knob on one side and a cylinder on the other.

71. Chain Bolts and Foot-Bolts.—A type of rim bolt used chiefly to secure the standing leaf of double doors is shown in Fig. 47 (a). These bolts are made in various sizes, finishes, and grades, and in both plain and ornamental design. In the illustration, the chain bolt is shown in (a), while the foot-bolt is illustrated in (b). One leaf of the double door is held in place by means of these bolts and the other leaf is fastened to it by the usual types of locks.



(a)

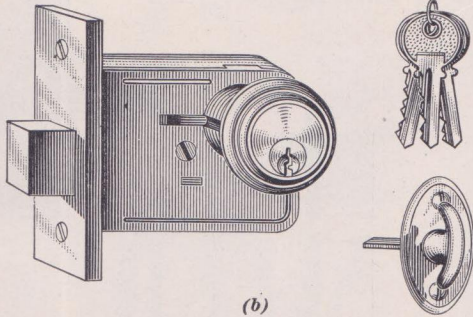

(b)

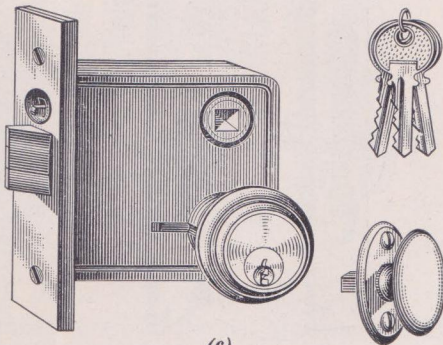

(c)

FIG. 46

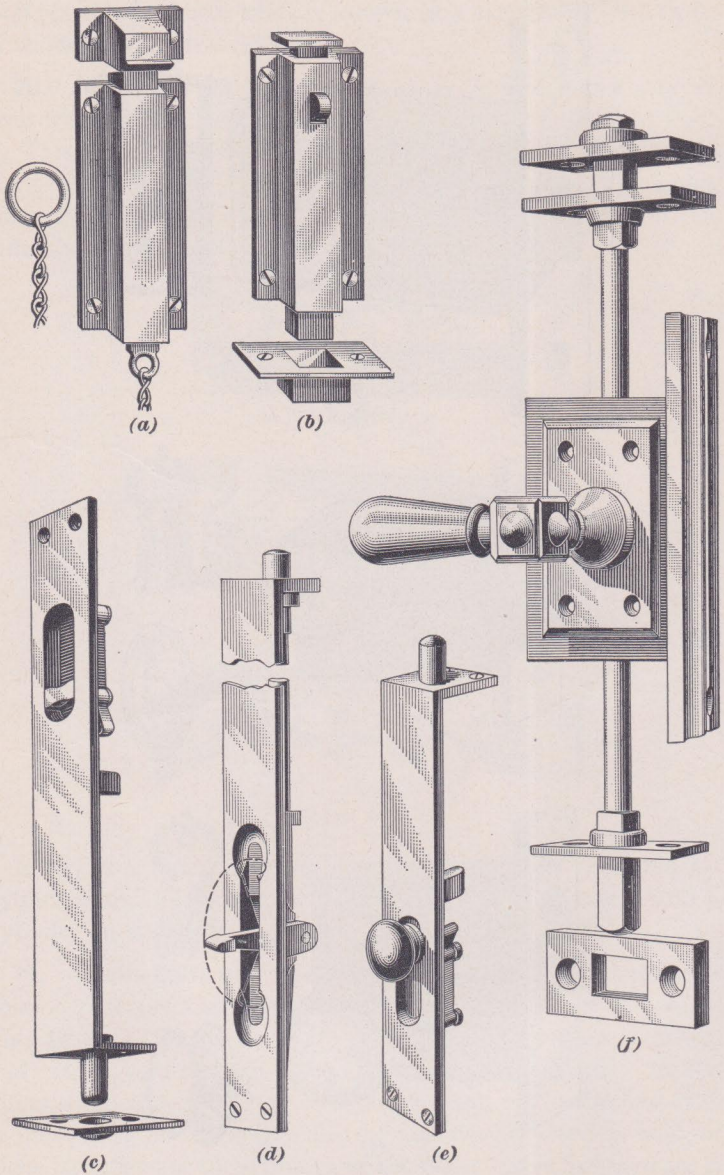

FIG. 47

72. **Flush Bolts.**—Bolts that are intended to perform the same function as chain bolts and foot-bolts, but are sunk into the stile of the door flush with its surface or edge, are known

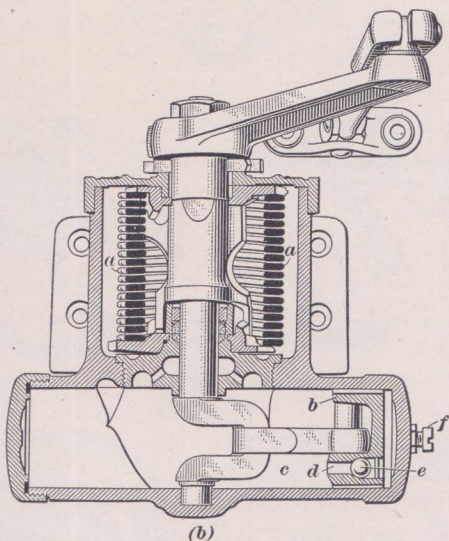
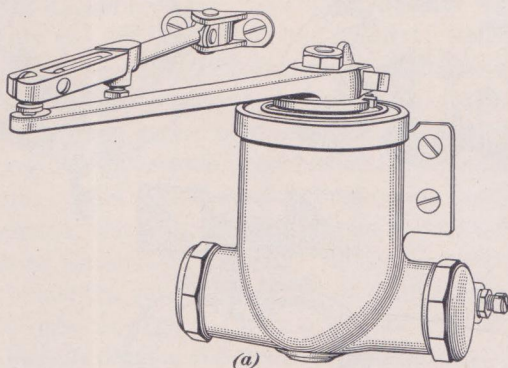

FIG. 48

as flush bolts. These bolts, which are illustrated in Fig. 47 (c) and (d), are made in various styles, grades, and finishes, from the smaller kinds for cabinet purposes to the large, double-mortise extension bolts. A flush bolt with a knob is shown in

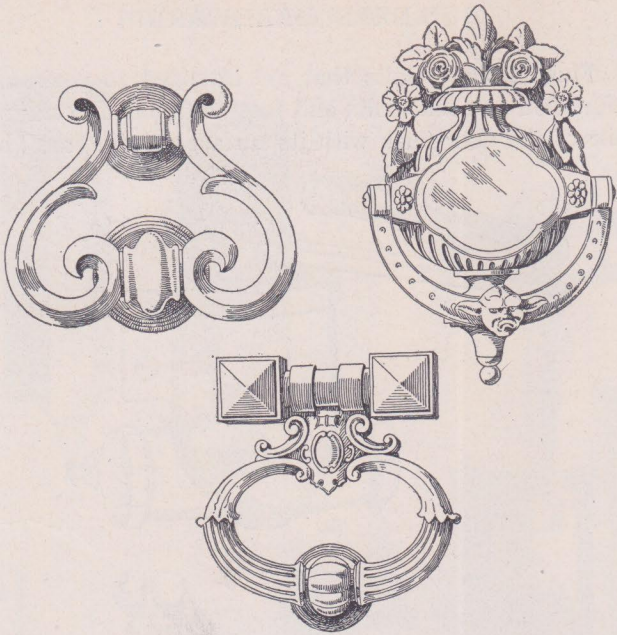
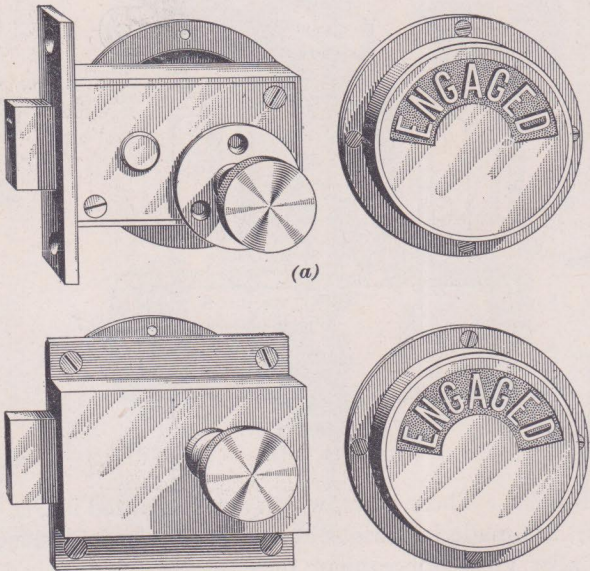

FIG. 49



(a)

(b)

FIG. 50

(*e*), while a heavy T-handle extension bolt is shown in (*f*), which secures the door at the top and bottom.

73. Door Closers.—Door closers are devices not only for closing doors but for controlling the speed at which they are closed and for preventing the slamming of the door. A door closer is shown in perspective in Fig. 48 (*a*), and in section in (*b*). The closing power of this device is obtained from the coiled spring *a* in (*b*), which is controlled by a piston *b* moving in a cylinder *c* filled with a special non-freezing liquid. As the door is opened, the piston is withdrawn in the cylinder, the liquid passing through the valve *d*. As the door starts to close, the ball *e* closes the valve and the liquid confined by the piston can escape only through the port controlled by the regulating valve *f*, thus preventing the door from slamming. When the door is opened and then allowed to close, it will close rapidly to within 5 or 6 inches, when it will close more slowly. The closer must be adjusted so as to exert sufficient force to close the door entirely, so that the latch will catch in the strike plate. There are several varieties of door closers that are adapted to light and heavy doors.

74. Door Knockers.—Although the medieval door knockers have been replaced by the modern electric bell, they are still used occasionally for decorative purposes, and, when required, they should be selected and specified with the finishing hardware. Door knockers are made in various styles, sizes, and finishes—in iron, brass, or bronze—to match the several designs expressed in hardware. The elaborateness of the designs of this somewhat ornamental piece of hardware is shown in Fig. 49.

75. Water-Closet Door Trim.—In the better class of work, as in hotels and public places, mortised thumb or knob bolts or, better, indicator bolts are used.

Indicator bolts, as shown in Fig. 50, made both mortise, as in (*a*) and rim, as in (*b*), are available for water-closet doors. In either case, the bolts are mortised into or placed on the

inside of the door with the indicator case on the outside. The indicator dial has a spindle on the back, and this engages with the knob that operates the bolt. When the bolt is thrown, the indicator shows the word "Engaged," and when turned back, the word "Open" appears.

Where stops are required for doors hung to marble partitions the type shown in Fig. 51 may be used. This stop has a clamp device that is attached to the marble slab by bolts and forms a combination stop and strike for the latch or bolt.

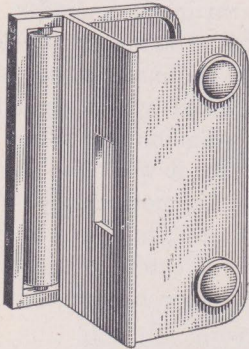

FIG. 51

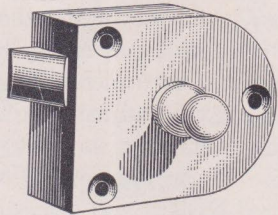

FIG. 52

Other water-closet specialties, which are not illustrated here but which are sometimes specified under hardware, are: Coat-and-hat hooks and toilet-paper holders. Each can be procured to secure to either wood, marble, or enameled steel as required.

76. Screen-Door Latches.—There is a light latch manufactured, either rim or mortise, for use on screen doors. It consists of a knob latch similar to a mortise latch or cupboard turn, but in addition to a hub, as in the former, it is furnished with a spindle and a pair of knobs, or lever handles. Latches for screen doors are also constructed with "stop-work," so that they cannot be operated from the outside except by means of a key. This latter latch is generally of the mortise type, having escutcheons on both sides.

77. Secret Gate Latch.—In Fig. 52 is shown a secret gate latch, which is used for office gates. Latches of this kind may be had in either the rim or the mortise type. They usually consist of a spring bolt that can be operated only by a concealed button or similar device. In the type of latch here shown, the concealed button that controls the latch is located on the lower edge. The knob shown is fixed, and does not operate the latch.

HAND AND BEVEL OF DOORS AND LOCKS

HAND AND BEVEL OF DOORS

78. General.—In order that the hardware of doors may be ordered intelligently, the hand and bevel of the door should be given, also the hand and bevel of the locks and the position of the spring latch. Reference to Fig. 53 will assist materially in understanding these matters.

79. Hand of Door.—The hand of a door is a term used to describe the manner in which a door is hung in the door frame.

1. The hand of a door is determined from the outside.

2. The outside of a door is the street side of an entrance door, the corridor side of a room door, and the room side of a closet door. The outside of a communicating door between two rooms is the side from which the butts are not visible when the door is closed.

3. If, on standing outside a door, the butts are on the left-hand side, as in (a), (b), (c), and (d), the door is a left-hand door. If the butts are on the right-hand side, as in (e), (f), (g), and (h), the door is known as a right-hand door.

4. If, on standing outside the door, the door opens away from the observer, as in (a), (c), (e), and (g), the door is a right-hand regular or a left-hand regular door. If, on standing outside the door, the door opens toward the observer, as in (b), (d), (f), and (h), the door is a right-hand reverse or a left-hand reverse door. In (a) is a left-hand regular door; in (e) a right-hand regular door, in (b) a left-hand reverse door, and in (f) a right-hand reverse door.

80. Bevel of Doors.—In some cases it is necessary to bevel the edge of the door to which the lock is applied. The reason

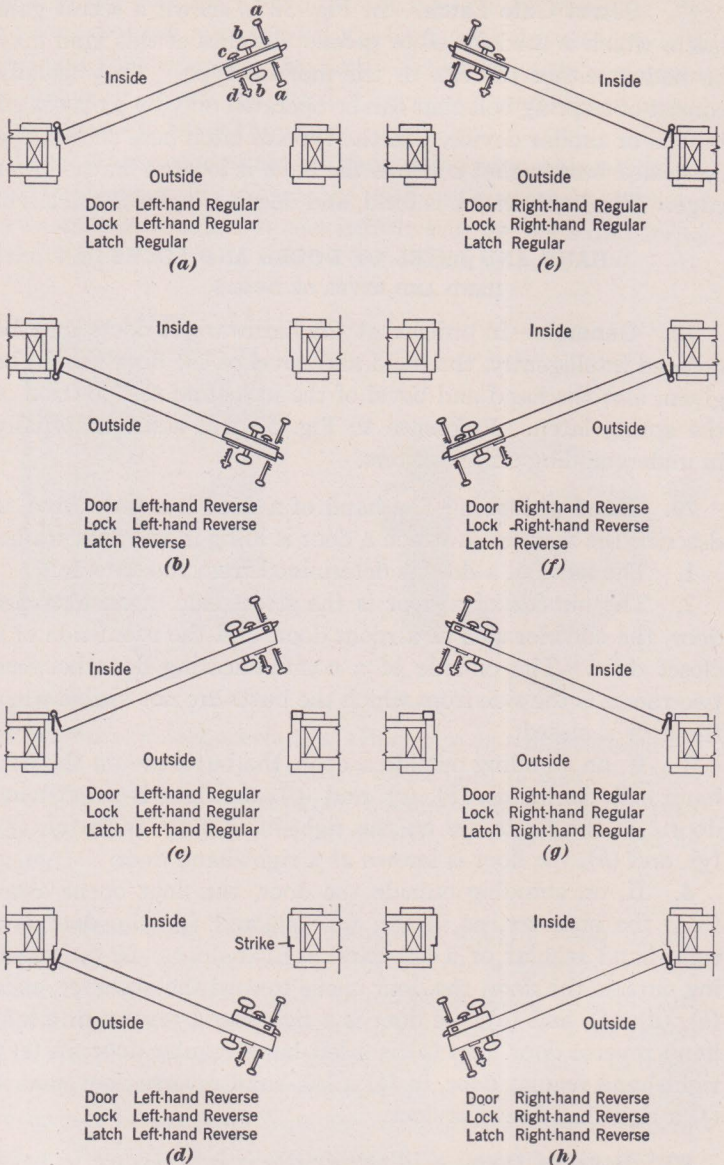
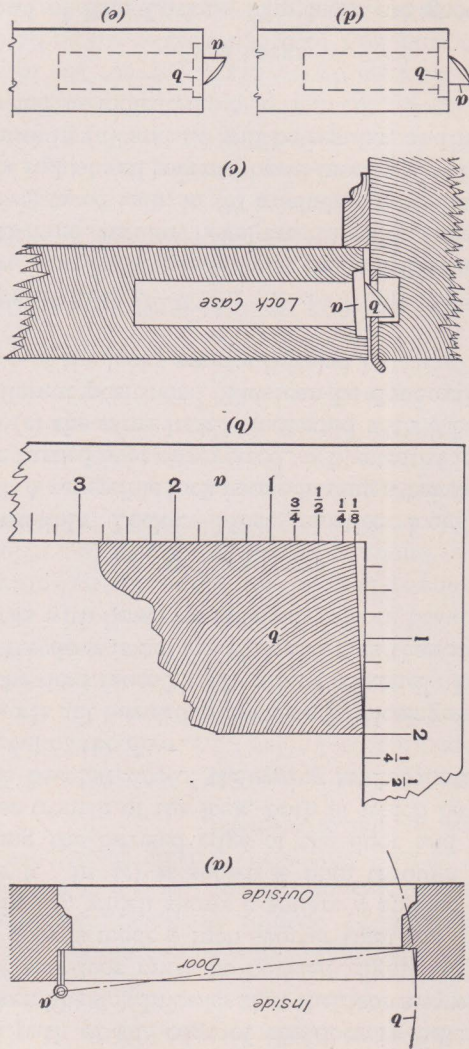

FIG. 53

FIG. 54



for this will be understood by inspecting Fig. 54 (*a*), which shows that the door swings on the center of the pin *a* of the butt. The path of the edge of the door is indicated by the curved broken line *b*. In order that the door may close tightly, the edge of the door must be beveled slightly. The outside face of the door is made $\frac{1}{8}$ inch shorter than the inner face, as illustrated in (*b*), which shows a square *a* applied to the edge of the door *b*. In (*c*) is shown a plan through the mortise lock, showing the beveled edge of the door and the beveled face-plate or front *a* of the lock, both of which have the same bevel. The beveled side of the spring latch *b* naturally slopes with the bevel of the door.

If the door is not beveled, allowance for closing must be made by fitting the door more loosely into the frame. In most ordinary work the door is not beveled and it is then not necessary to order locks with bevel face-plates.

MORTISE LOCKS

81. Reversible Locks.—Most mortise locks are made reversible. A reversible lock is one having a beveled latch bolt that can be turned over or reversed, as illustrated in Fig. 54 (*d*). In (*d*) and (*e*) the same lock is indicated with the spring latch *a* set in different positions. This can be done only where the face-plates *b* of the locks are not beveled.

82. Beveled Locks.—When the door and the face-plate of the lock are beveled, the lock must be described as in Fig. 53. In (*a*) a left-hand, regular, bevel-faced lock, in (*e*) a right-hand, regular, bevel-faced lock, in (*b*) a left-hand, reverse-bevel face, and in (*f*) a right-hand reverse, bevel-face lock will be specified.

The latches in (*a*) and (*c*) will be regular, and in (*b*) and (*f*) will be reverse, as indicated.

RIM LOCKS

83. Hand of Rim Locks.—Rim locks are generally placed on the inner side of a door. If placed on the outside they could be removed easily by means of a screwdriver and the door could then be opened.

In Fig. 53 (*c*) (*d*) (*g*) and (*h*) are shown doors and locks in different positions. Thus, in (*c*) is shown a left-hand regular door, with a left-hand regular lock and latch. In (*g*) is a right-hand regular door with a right-hand regular lock and latch.

84. Reversible Rim Locks.—Some rim locks can be reversed in their operation by opening the lock case, taking out the spring latch, and turning it around as can be done with reversible mortise locks. This permits using these locks in either of two positions, regular or reversed.

85. Appliances for Operating Mortise and Rim Locks. Locks are operated by knobs, keys, cylinders, and turn knobs, which are used in different combinations. On the diagrams in Fig. 53 are indications of various devices that can be used to work the locks. These devices are not all used on one door but may be used in various combinations.

In (*a*) are shown keys for dead bolts at *a*; at *b* are door-knobs; at *c* is a turn knob, or thumb knob; at *d* is a cylinder with a flat key. The knobs are generally used on both sides of the door. A key *a* is generally used on the inside of the door and may or may not be used on the outside of the door. A cylinder may be used on the outside of the door to operate the spring latch or the spring latch and dead bolt. The various operating devices are indicated on all the locks.

HARDWARE FOR SPECIAL KINDS OF DOORS

EMERGENCY-EXIT DOOR

86. Outside doors for schools, theaters, auditoriums, and other places where numbers of people congregate, may be equipped with hardware that permits the locked doors to be opened readily from the inside of the building without the use of a key or knob. In case of panic, fire, or other emergency, the ordinary door hardware might prevent the quick opening of the doors, and lead to a catastrophe. The hardware used for doors in such positions is known as emergency-exit door hardware, panic-door hardware, fire-door hardware, etc. The latches of the doors are arranged so that they may be retracted or drawn back by a light pressure on a bar across the entire

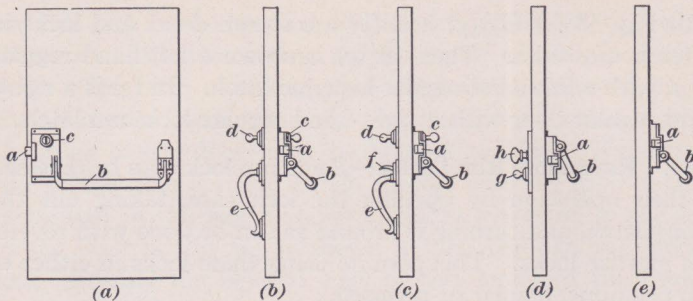

FIG. 55

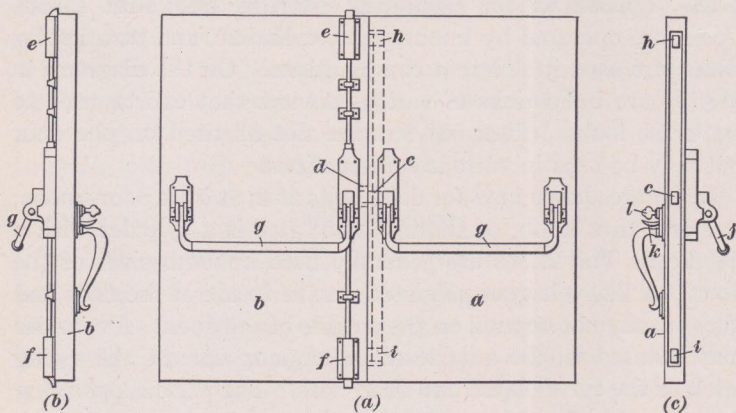

FIG. 56

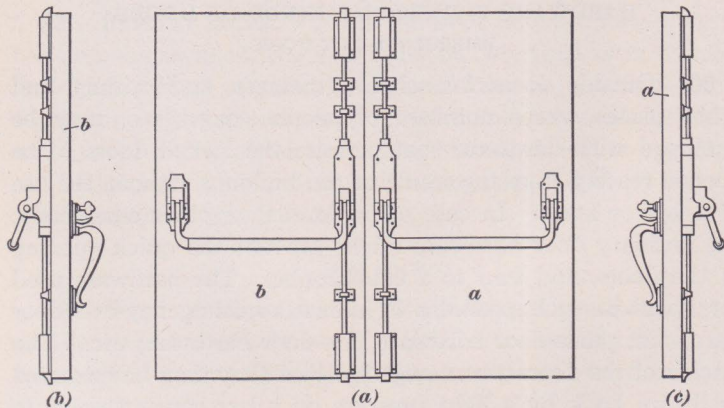

FIG. 57

door, or in some cases by either a pressure or a pull on the bar. These doors cannot be locked from the inside against exit at any time, although they may be locked against entrance from the outside. Such doors are hung to open outward in all cases. Single or double doors may be used in an opening, and somewhat similar hardware is designed for use with revolving doors.

Emergency-exit door hardware is made for wooden doors, kalamein doors, and metal doors. The doors may lock automatically from the outside, or may be locked from the outside or inside, or the outside of the door may have no provision for either locking or opening.

In Fig. 55 are shown some of the combinations of emergency-exit door hardware that may be used on a single door. In (a) is an inside view of a door. The latch, or bolt, of the lock is at *a*, and fits into a strike plate in the jamb. The bolt is retracted by pressing down or lifting up on the cross-bar *b*. A cylinder lock is shown at *c*. This locks against entrance from the outside except by means of a key, as at *d* in (b), but permits egress from the inside by a pressure or lift on the cross-bar *b*. At *e*, in (b), is a pull handle, for entrance from the outside. In (c) a thumb latch *f* is added to the pull handle *e*. In (d) a key *g* unlocks the knob *h*, permitting it to retract the latch *a*. In (e) no hardware appears on the outside, the door being opened from the inside only by means of the cross-bar *b*. In any case, the doors cannot be locked against egress.

In Fig. 56 is shown one method of arranging the emergency exit hardware on a pair of doors. The door *a* in (a) is known as an active door, as it closes against the inactive door *b*, which may remain closed. The latch *c* enters a strike plate *d* on the door *b*. In (b) is a section of the inactive door *b*. Bolts at *e* and *f* are retracted by means of the cross-bar *g*. With kalamein doors a three-bolt mechanism is sometimes used, additional bolts as shown in dotted lines at *h* and *i* in (a) being used. This mechanism is indicated also in (c), the bolts being placed in the stile of the door as at *c*, *h*, and *i*, and being retracted by means of the cross-bar *j*, from the inside, or by means of the thumb latch *k* when unlocked by the key *l*. Any of the combinations shown in Fig. 55 (b), (c), (d), or (e) may be used on this door.

In Fig. 57 (a) the doors *a* and *b* both have hardware similar to that used on door *b* in Fig. 56 (a). Either door may be opened from the inside by means of the cross-bars, or from the outside by any of the combinations already described. Sections (b) and (c) show the handles and latches of doors *b* and *a* in view (a).

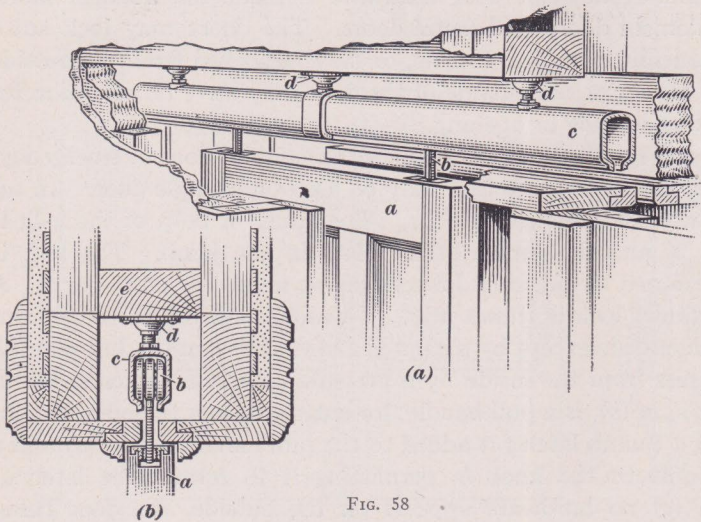
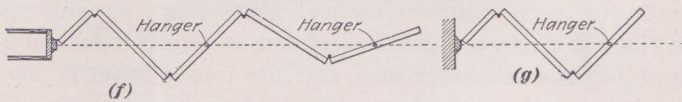
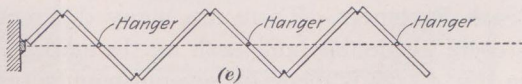
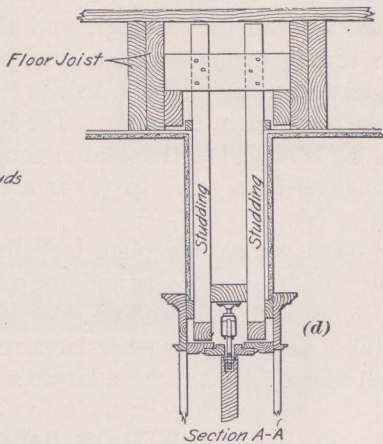
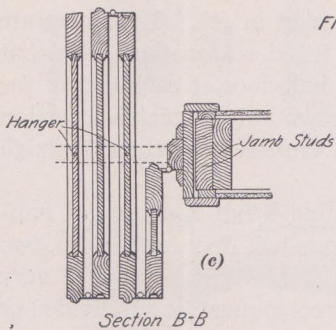
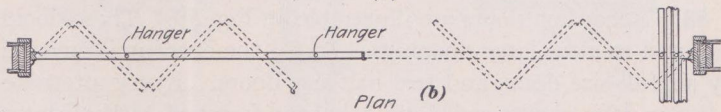
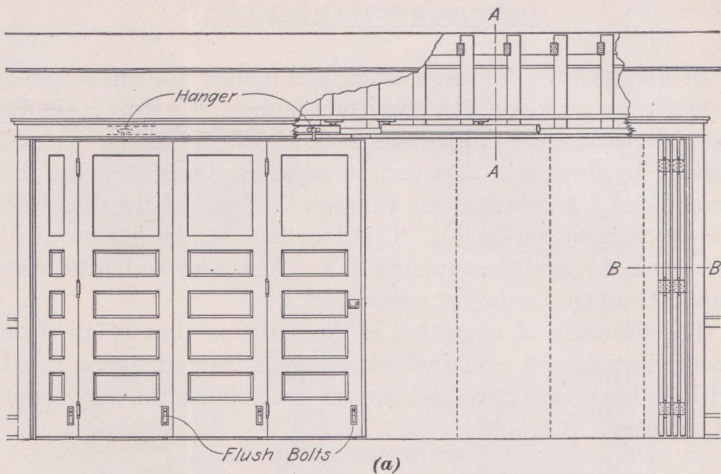

FIG. 58

The details of the devices for locking or operating emergency-exit doors vary somewhat with different manufacturers. Catalogs should be consulted when considering the use of such doors or hardware.

SLIDING DOORS

87. Sliding doors that move laterally are suspended on hangers that have wheels at the tops. These wheels run in metal tracks. When these doors are used between rooms the hangers and tracks are generally concealed in spaces between the head jamb of the door and a supporting lintel for the tracks above. Sliding doors are used for doors between living rooms and dining rooms in homes, for doors separating large rooms in hotels and churches, for garage doors of various types, and for fire-doors.



In Fig. 58 (*a*) is shown a track and hanger used to suspend a door between rooms in a house or a hotel. The door is shown at *a*, the hanger at *b*, and the track at *c*. The hanger is suspended by devices *d* that can be adjusted so as to make the track level. A cross-section through the head of the door and the track is shown in (*b*). The door is at *a*, the hanger at *b*, the track at *c*, and the supports at *d*. At *e* is a wood lintel that supports all the parts just mentioned.

The principle of operation is the same as that of all door hangers on tracks. The wheels of the hangers may be fitted with ball bearings or roller bearings to facilitate the movement of the door.

ACCORDION DOORS

88. Accordion doors are illustrated in Fig. 59. These doors are used to close large openings. In (*a*) the opening is covered by six full-size doors and two half-size doors. Every alternate full-size door is suspended by a hanger fastened to the center of the top-rail of the door, and the hangers run on tracks. This arrangement is indicated in plan in (*b*). The doors are hinged together and each door is fitted with a flush bolt that enters a socket in the floor. The half-door at each end of the opening is hinged to the joint as shown in (*c*), which is a section through *B-B* in (*a*). In (*d*) is a cross-section track through *A-A* in (*a*).

In (*e*) is shown the plan, including 5 full doors and 1 half-door. In (*f*) are 4 doors and one one-half door, and in (*g*), two full doors and one one-half door. This type of door is very useful in school rooms when large rooms must be subdivided or small rooms joined to form larger rooms.

WINDOW HARDWARE

89. **Sash Fasteners.**—There are many different makes of sash fasteners for double-hung sash on the market. The type shown in Fig. 60 (*a*) is made by several manufacturers, and it can be obtained in iron or steel in all finishes, and also in bronze. The lock is composed of a helical cam *a*, which is fastened to the top-rail of the lower sash, and fits into a hook, or lug, *b*, that is secured to the bottom rail of the upper sash. The

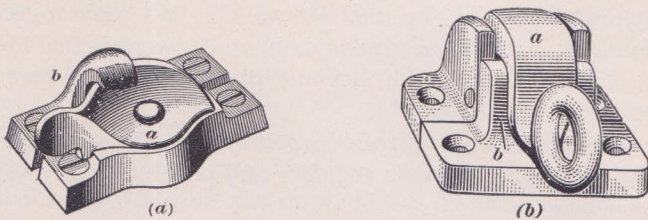

FIG. 60

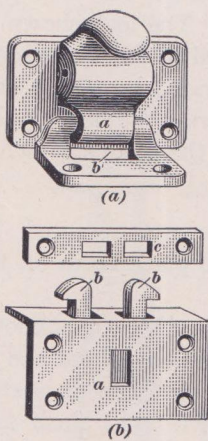

FIG. 61

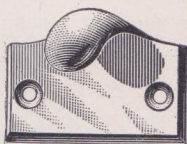

FIG. 62

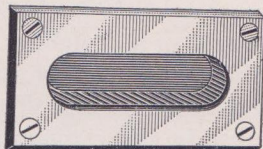
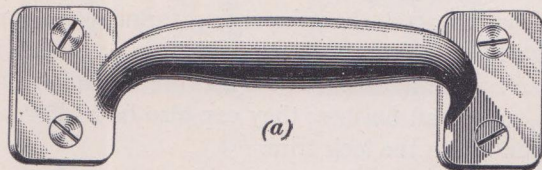
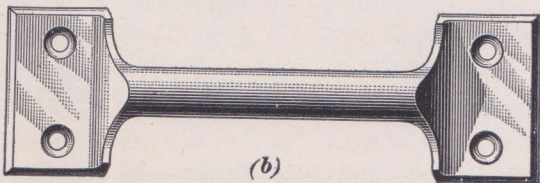

FIG. 63



(a)



(b)

FIG. 64

rotary movement of the cam draws the two sash together horizontally, raising the upper sash and lowering the lower sash. This holds the sash fast and prevents rattling and air leaks.

In the lock shown in (b) the hinged hook *a* drops down over the lug *b*, drawing the sash together and preventing any vertical movement.

In Fig. 61 (a) is shown a sash lock in which a spring causes the hook *a* on the sash to enter the slot *b* on the sill, thus preventing the lower sash from being raised. The lock shown in (b) is designed to be attached to the top-rail of the upper sash, holding the sash closed. This lock is operated by means of a sash hook on a pole, as in (c), the hook entering the slot *a* in (b). A downward pull releases the latches from the plate *c*, which is secured to the head jamb of the frame.

90. Sash Lifts.—While sash lifts are not required for cheapest work, it would seem advisable to place them on the lower sash of all buildings.

The common type of sash lift illustrated in Fig. 62 is known as the hook sash lift. This lift is extensively used and can be procured in any grade or weight, in either cast iron or in steel or bronze metal, and in any finish desired. The flush sash lift, the general type of which is shown in Fig. 63, makes a better appearance than the hook lift, and is considerably stronger from the fact that the casing forming the grip is let into the lower rail of the sash, and the strain is taken by this, rather than by the screws. These lifts are made in either steel or bronze, and in all finishes; they can also be had ornamented to correspond with the lock trim.

For heavy sashes, such as those in public and commercial buildings, the bar sash lift illustrated in Fig. 64 (a) is the best and should always be used. A sash lift similar to the type shown at (a) is sometimes fastened to the under side of the meeting rail of the upper sash for the purpose of lowering the sash, as in (b).

91. Sash Sockets and Pole Hooks.—In buildings having high ceilings, where the top sash is some distance from the

floor, as is likely to occur in institutions, schools, and factories, it is necessary to provide "pull-down" poles for the purpose of raising and lowering the upper sash. The hooks used on the ends of such poles, which are made of some tough wood, are as illustrated in Fig. 65 (a) and (b). Unless the upper sash is furnished with metal plates that have a hole, or aperture, the pole will be used against the upper rail of the window sash and thus mar the woodwork. The plates, or metal sockets, to engage the sash and pull-down poles, are illustrated in (c), (d), and (e). They may be had in all metals and finishes and in several sizes.

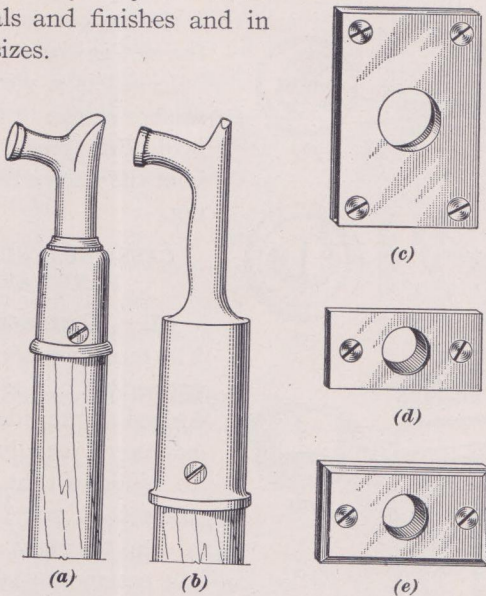

FIG. 65

92. Stop-Bead Screws and Washers.—Stop-bead screws and washers are used in fastening to the window frame the stop-bead or stop *a*, Fig. 66, which holds the lower sash in a double-hung window frame in place. The stop-bead is ordinarily nailed to the window frame. If, however, the stop-bead binds against the sash, or if it is necessary to remove the stop-bead and sash in order to open the pockets in the frame, the nailed stop-beads are difficult to remove.

When stop-bead screws and washers, as shown in (b), are used, the screws can be easily removed and the stop-bead taken off. When the stop-bead is too tight and interferes with raising the sash, it is desirable to move the stop-bead away from the sash for a small distance. When a stop-bead screw and a slotted countersunk cup washer, as shown in (c), are used, the screw can be loosened, the stop-bead moved as far as is necessary, and the stop-bead screwed into the new position. This can be done without any injury to the stop-bead.

The stop-bead is cut with a slot to correspond with the slot in the washer.

In (d) is a view of the washer shown in (c). The projecting parts (a) prevent the washer from turning.

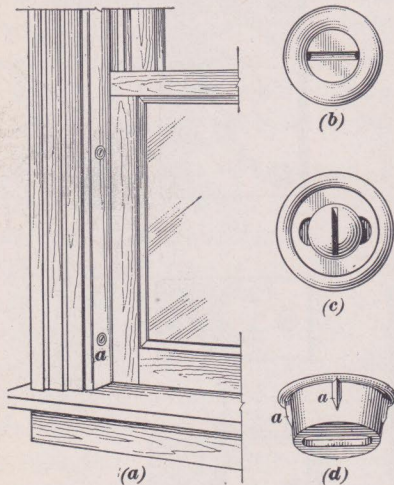

FIG. 66

CASEMENT-WINDOW HARDWARE

93. Casement Trim.

The term casement applies properly to any sash hinged at the sides. It is, however, usually limited to windows that have the sill set at some distance above the floor. Where the casement sash extends

to the floor, the term French window is generally applied.

Casement windows may swing into or out of the room. Those swinging out are the more weatherproof. A casement window may consist of a single sash or a pair of sash.

94. Butts.—Casement windows are hung at the sides on plain butts or extension butts. The plain butts are similar to those used for doors. Extension butts, shown in Fig. 67 (a) and (b), are used on casements that open outward and have the knuckles extending about 2 inches outside the face of the

sash. When the sash is open, as in (a), a space *a* about 4 inches wide is formed between the sash and the window trim, which allows of cleaning the outside of the glass by reaching out from the room. In (b) is shown an enlarged view of an extension butt.

For sash opening outward the butts should be made of brass and have fast joints. They may be made, however, of galvanized iron or steel with brass pins so that they will not rust.

For sash opening into the room, fast butts are used and should match the other hardware used inside the room.

95. Casement Adjusters.

In order to hold hinged or pivoted sash in a partly or fully open position, casement-sash adjusters are used. One form of casement adjuster is illustrated in Fig. 68 (a). In this case the sash is pivoted at the top and bottom, but this device can be applied equally well to a sash hinged at either side. In (b), (c) and (d) are shown modifications of this device, which consist in each case of a rod *a* attached to the sash by

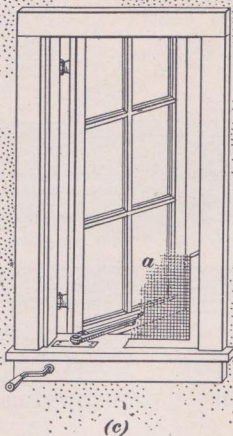
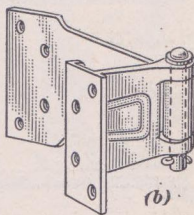
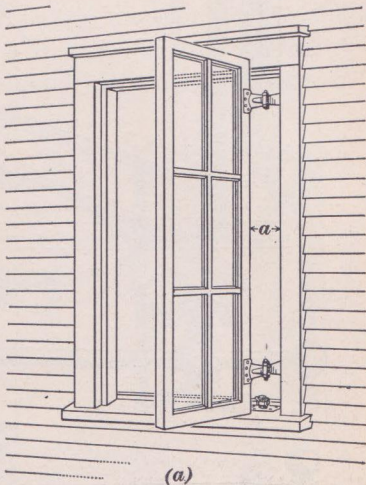
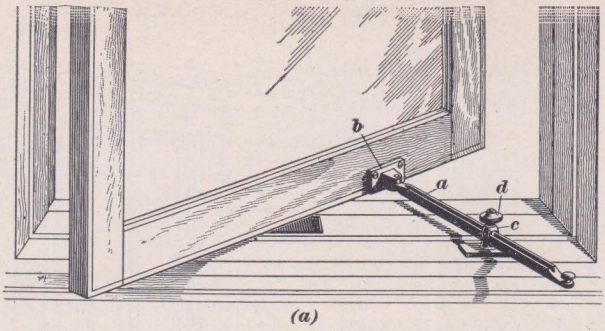
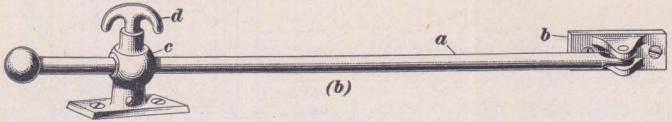

FIG. 67



(a)



(b)

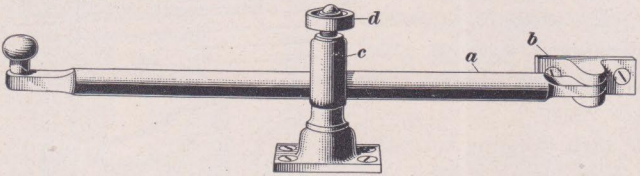

(c)

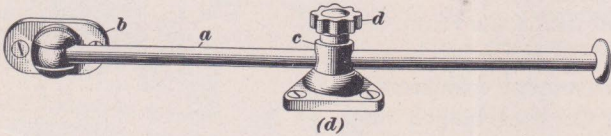

(d)

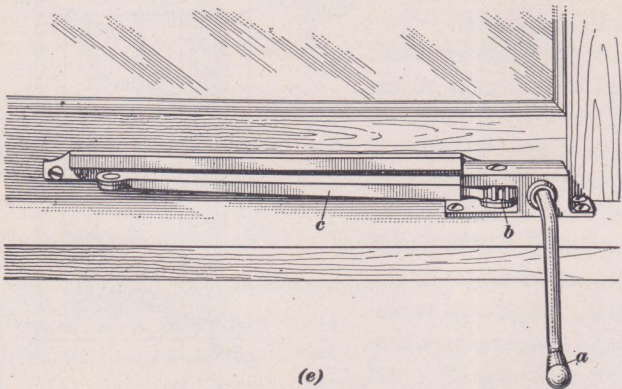

(e)

FIG. 68

means of a flexible joint *b* and sliding through the rotating shank *c*. The rod may be pushed or pulled through the shank and can be held in any desired position by tightening the screw *d*.

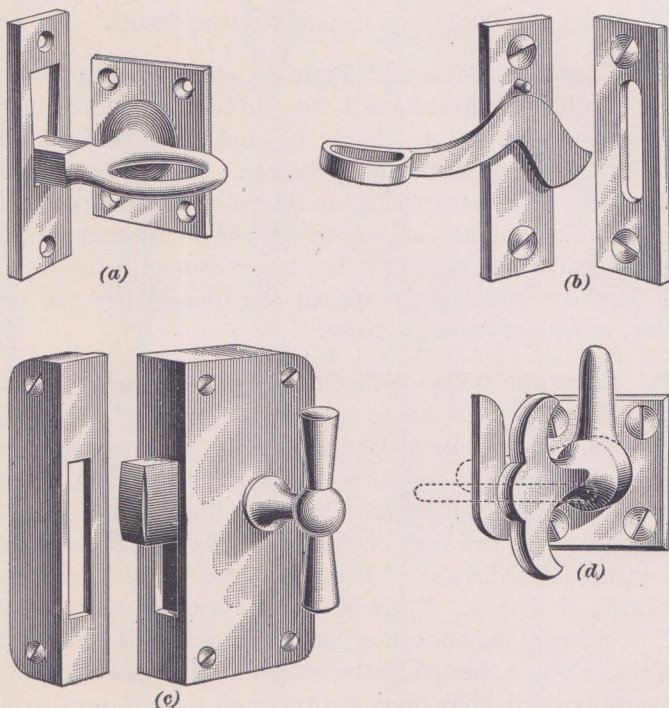

FIG. 69

96. Sash-Operating Devices.—In Fig. 68 (*e*) is shown a device for opening and closing a hinged sash by turning the crank *a*. The crank turns the gear wheel *b*, which causes the arm *c* to push the sash open or to close it. The devices are easily applied when the sash opens outward. As they operate from the inside of the building, they provide security, as the sash cannot be opened from the outside.

When a mosquito screen is to be used, it can be placed inside the sash and the sash opened without interfering with the screen.

In Fig. 67 (c) is shown a sash adjuster that is placed below the window sill when a screen *a* is used. The adjuster is operated by a crank in the apron.

These devices are made usually of brass or bronze, although rust-proofed steel and iron are used to some extent.

97. Casement Bolts and Fast.—Casement sash may be provided with any good form of top and bottom bolts or hinged sash fasteners, but these should be supplemented by a good latch or cupboard catch at the center. Special turnbuckles, or casement fasts, constructed as shown in Fig. 69, are on the market. The catches shown in (a), (b), (c), and (d) will securely fasten the sash, but the types shown in (a) and (b) will draw the sash tightly against the frame when the turnbuckle, or fast, is drawn in place.

98. Cremorne Bolts.—The Cremorne bolt is used for casement windows. This device consists of a vertical rod divided at or about the middle of its length, thus making two pieces, and is operated by a knob, or handle, at that point. Three types of ornamental Cremorne bolts are illustrated in Fig. 70. The upper and lower ends of the rods, or bolts, slide vertically and in opposite directions, being operated by the turning of the knob, or handle. These bolts are furnished with suitable strikes, either of the plate or of the box form, which are attached to the window at the top or the bottom. Since the ends of the bolts are beveled, they press the two sash tightly together and against the sash frame when they are thrown in. A single movement of the knob, or lever handle, is sufficient to release both bolts.

99. Espagnolette Bolts.—In Fig. 71 are shown three types of Espagnolette bolts, which are similar in construction to the Cremorne bolts. They consist of vertical rods, but instead of being in two pieces, as in the Cremorne bolt, they are in one piece. The rods have hooks at each end, and, by a rotary motion, engage pins, or plates, in the window frame. These bolts usually are operated by a pendant handle which, when lifted to a horizontal position, will release the rod so that it

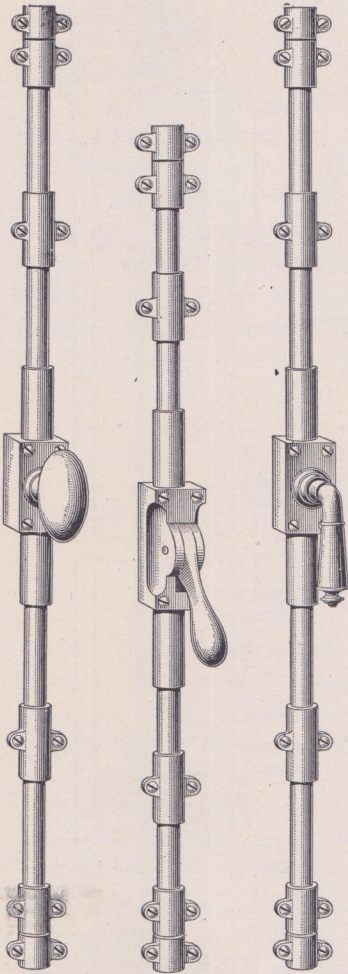

FIG. 70

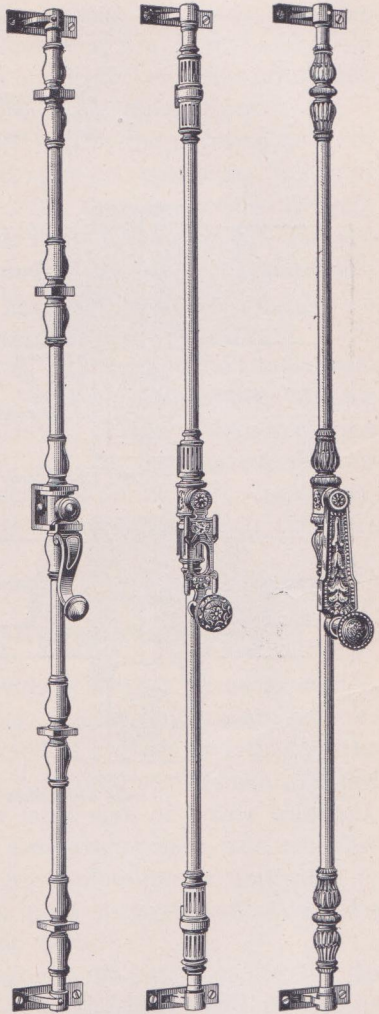
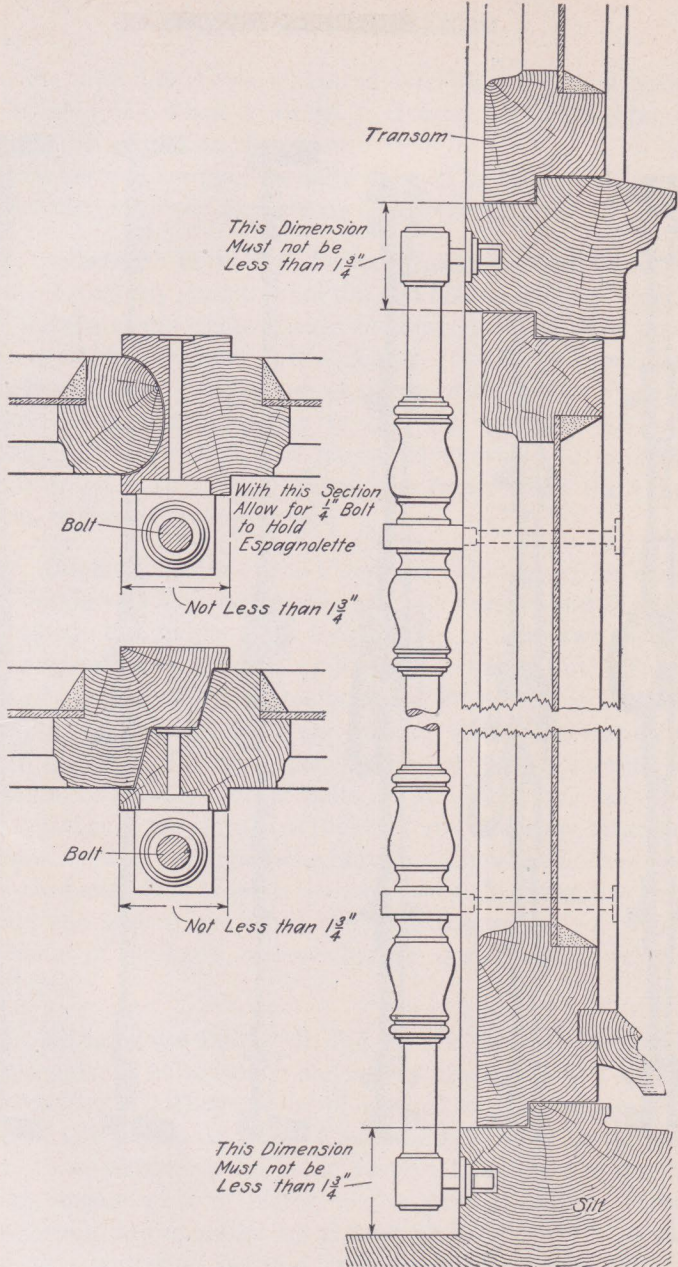

FIG. 71



may be rotated to fasten or to release the sash. The Espagnolette bolt is usually heavier than the Cremorne and exerts more power in forcing the sashes against the frame; it is also more expensive. Both bolts, however, are available for use on doors as well as on windows, and lend themselves admirably to decorative treatment, as shown in the illustrations.

The same care should be exercised in the selection of these bolts as for other hardware, and when ordering them, full-sized details should accompany the order, showing sections through the top rail and head-jamb, the bottom rail, the sill, and the lock stile. The exact measurement of the height and the width of the openings should also be given, and the information should state whether the sash swings inward or outward. The hand of the active leaf, as well as the height of the handle from the floor, should also be given. In Fig. 72 are shown sections through a casement sash, illustrating the conditions requiring the use of Espagnolette bolts, and, as just stated, sections similar to these should be furnished the dealer, or manufacturer, so that these bolts will fit the construction when they are delivered.

TRANSOM SASH HARDWARE

100. Sash Centers and Pivots.—When a transom sash is hung at the top or the bottom, regular hinge butts may be used; but where a sash is pivoted at the center either on the sides or at the top and bottom, a pivoted arrangement, termed a sash center, is needed. For large sash or heavy transoms, and especially for those that are exterior sash, the rabbeted center should be used. This type of center is illustrated in Fig. 73; its construction gives great strength and completely closes the joint against light and water.

An excellent type of sash center is illustrated in Fig. 74, the method by which it is attached to the frame and sash being clearly indicated. By this arrangement, the two parts of the center fold, or butt, against each other and form a tight joint, the stop-bead for the sash at the top and bottom being arranged as indicated at *a*.

In Fig. 75 (a), (b), (c), and (d) are shown several sash centers of the type used for common work.

101. Transom Lifts.—The transom lifts illustrated in Fig. 76 are devices for operating and fastening the transoms over doors and windows. These devices are used extensively in hotels and office buildings. They are made in various styles

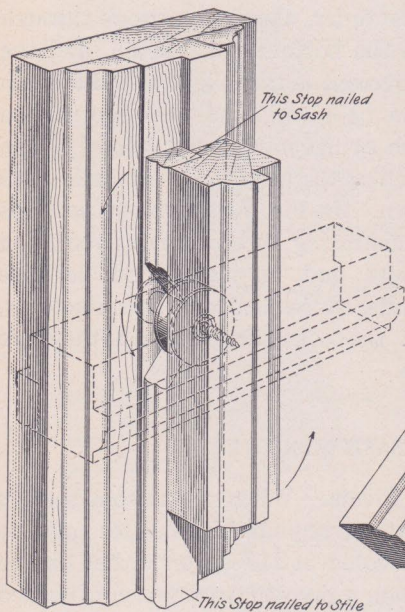

FIG. 73

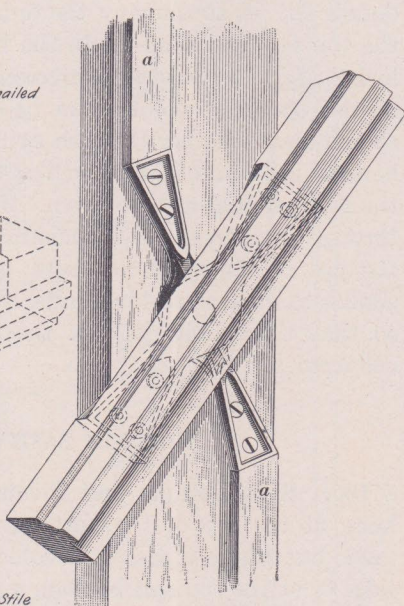

FIG. 74

and sizes to meet the several requirements, and may be visible or concealed. The types shown in (a), (b), (c), and (d) consist of vertical sliding rods *a* that are placed on the door trim, with arms *b* at the top connecting the rods with the sash. Near the bottom of the rods are clamps, or grips, on the trim, which hold the rods in any desired position. By a vertical movement of the rods, the sash are caused to swing.

Transom lifts may be had for transom sash that are pivoted at the center or for those which are hinged at the top or at the

bottom. In (a) and (b) are shown the transom lifts arranged for center-pivoted sash; in the former, the bottom of the sash opens outward and the top opens inward, while in the latter the bottom of the sash opens inward and the top opens outward. In (c) the device is shown with the sash hinged at the top, while in (d) the sash is hinged at the bottom.

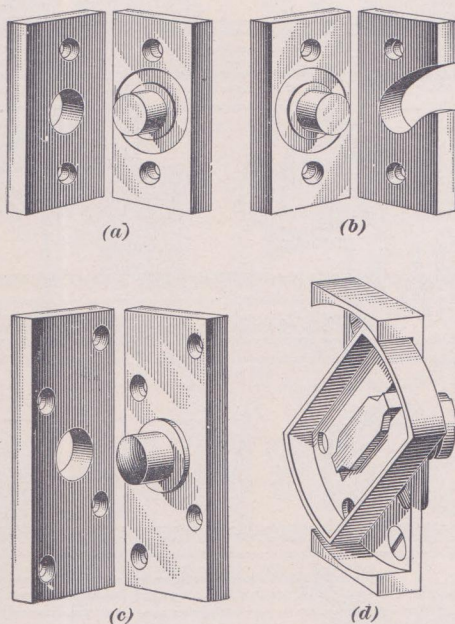
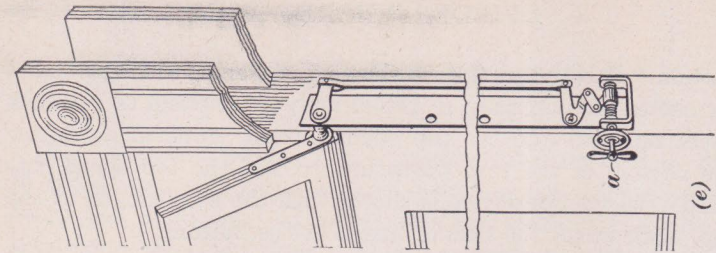

FIG. 75

Transom lifts may be obtained in steel, bronze, or brass. They are made with rods of $\frac{1}{4}$ -, $\frac{5}{16}$ -, $\frac{3}{8}$ -, and $\frac{1}{2}$ -inch sizes, depending on the weight of the sash and the rigidity and solidity desired. For good work, the $\frac{3}{8}$ - and $\frac{1}{2}$ -inch diameters are used. The rods may be obtained in lengths of from 3 to 12 feet. In specifying or ordering transom lifts, the rod should always be sufficiently long to reach within 5 feet of the floor.

In (e) the sash is hinged at the bottom, and the operating mechanism is concealed, the handle *a* being the only visible part. Concealed transom operators may be arranged to open



(e)

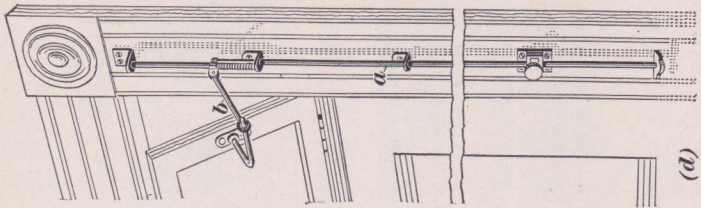

(d)

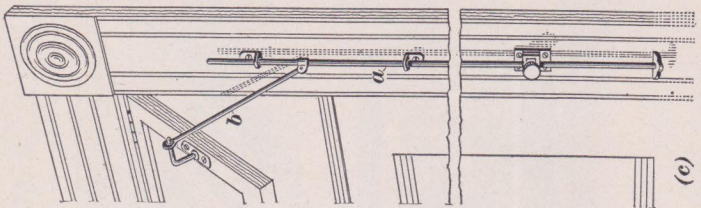

(c)

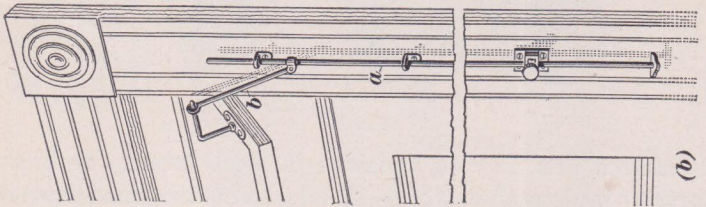

(b)

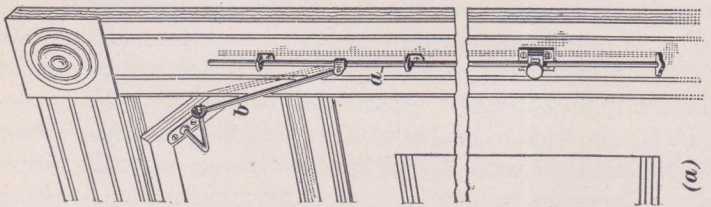

(a)

FIG. 76

the transom in or out, the sash being hinged at the top or at the bottom, or pivoted at the center.

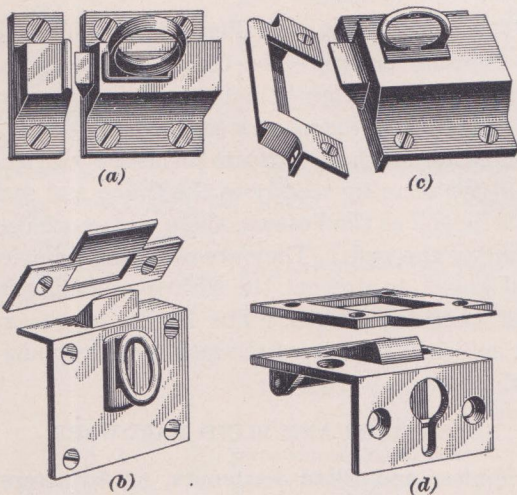

FIG. 77

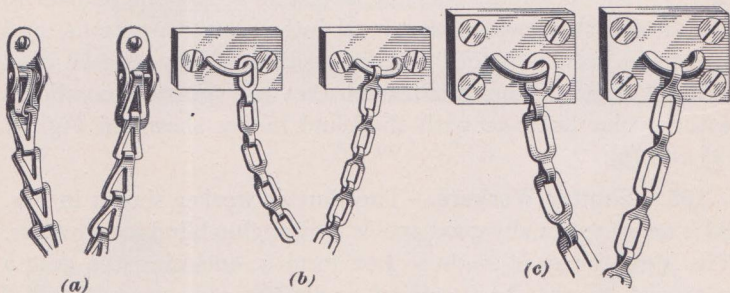

FIG. 78

102. Transom Catches.—In Fig. 77 are illustrated types of transom spring catches, or bolts. These devices are provided in the several forms shown to meet various conditions. Those shown in (a), (b), and (c) have a ring, or an eye, in the handle, to which an operating cord may be suspended, or into which a pull-down hook may be inserted, to operate the sash. The transom catch in (d) is made expressly for operation by means

of a pull-down hook. In very wide windows, for the purpose of limiting the opening of the sash, these catches should be used with chains instead of with transom lifts.

103. Transom Chains.—In Fig. 78 are illustrated several types of transom chains. The chains shown in (a) and (b) are suitable for sash weighing not more than 25 pounds, while that in (c) is sufficiently strong for sash weighing over 25 pounds. These chains are fastened to cleats furnished with countersunk screw holes for securing readily to the frame and sash. When the sash is hinged at the bottom, these chains are used to limit the opening of the sash. They are sometimes employed as an additional guard, to prevent the sash from falling in case the sash lifter becomes broken. The length of the sash chain should be sufficient to prevent the sash from dropping below the horizontal position.

SHUTTER AND BLIND HARDWARE

104. Shutter and Blind Fasteners, or Adjusters.—One of the most convenient fastener for shutters, or blinds is shown in Fig. 79. These fasteners or adjusters secure the shutter in the closed, the open, and several intermediate positions, and are made both japanned and galvanized. They can be used with all styles of hinges, although they are generally combined with regular butts or with the blind hinges shown in Fig. 21 (a) and (b).

105. Shutter Workers.—The shutter worker shown in Fig. 80 is an exceptionally good article for hanging blinds or shutters. The lower hinge is made in box form *a*, enclosing the gear *b* necessary to operate the blind or shutter *c*; a square shaft *d* connects this with a lever handle, or crank, *e* fastened to the casing inside the building, thus allowing the user to operate the shutter from the inside without opening the sash or screen. The cog gearing in the lower hinge will hold the shutter in the closed, the open, or any desired intermediate position without the use of any other device.

106. Turnbuckles.—The devices shown in Fig. 81 are known as turnbuckles and are employed for holding blinds and

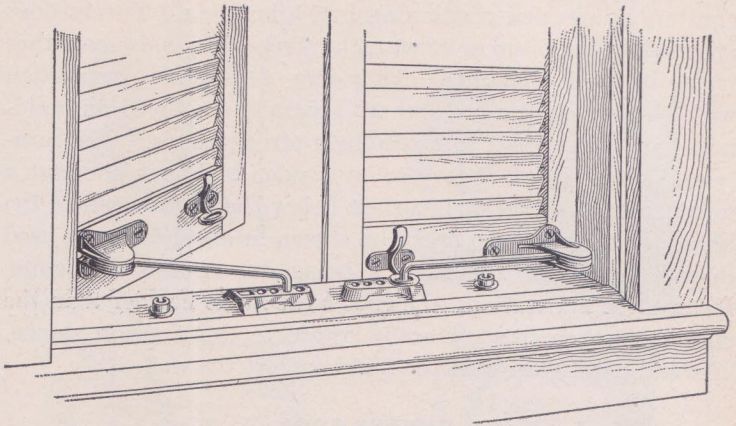

FIG. 79

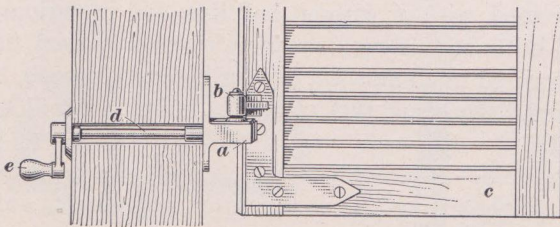

FIG. 80

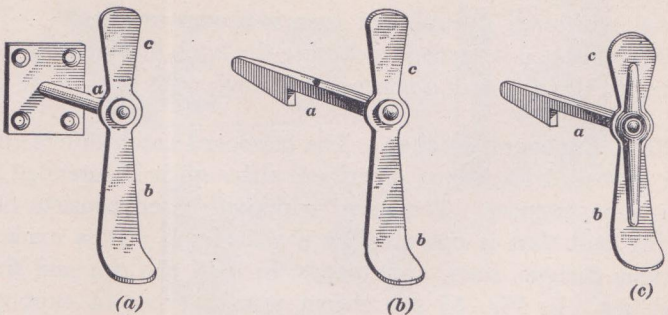

FIG. 81

shutters in an open position against a building. Turnbuckles are made of cast iron or of wrought steel, and for use on either frame or brick buildings. They may be used in connection with all styles of hinges, and are generally employed on buildings that are exposed to exceedingly strong winds. The turnbuckle shown in (a) is for use on wooden buildings, the part *a* being screwed to the wall surface below the bottom rail of the blind or shutter. The examples shown in (b) and (c) are used in masonry walls, the parts *a* being driven into the joints. In all three illustrations, the ends *b* are made heavier than the ends *c*, so that they naturally rotate to the position shown. The end *c* will then hold the blind against the wall.

CABINET TRIM

107. Hinge Butts and Hinges.—For cabinetwork, small, light hinge butts are used. These may be obtained in either bronze or steel, with or without ball tips, and in various sizes. The steel butts of this type are more commonly used, as they can be procured in all finishes; but for high-grade work, bronze is employed. The usual type of cabinet hinge butt is illustrated in Fig. 82.

A surface hinge is sometimes used in place of a butt, in order to eliminate the fitting that is necessary where butts are used.

108. Cupboard Latches and Turns.—In Fig. 83 is shown a cupboard latch in which the knob and the spring latch operate together; when the door is closed the latch holds the door in a closed position. A cupboard turn is shown in Fig. 84. The turn, or knob, *a* is turned to operate the latch *b*, which projects owing to the action of a concealed spring.

109. Cupboard Catches.—The cupboard catch differs from the cupboard latch just described, although it is intended for the same purpose. The usual cupboard catch consists of a spring bolt that is operated by a slide knob. It is made in various designs, sizes, and shapes, in both the rim and flush varieties. In Fig. 85 are shown several types of cupboard catches.

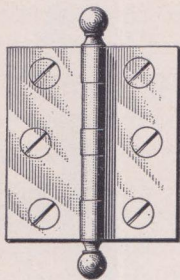

FIG. 82

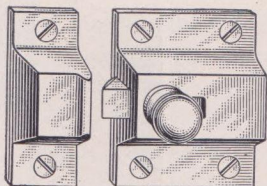
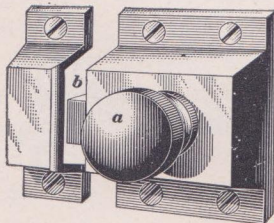

FIG. 83

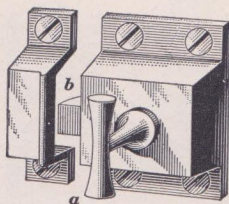

FIG. 84

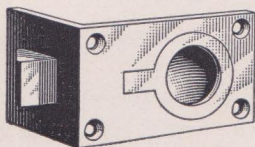
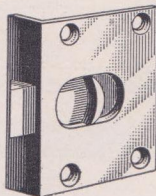
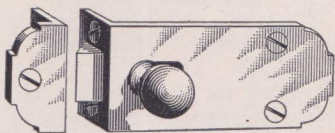
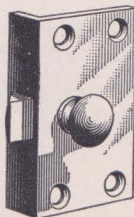
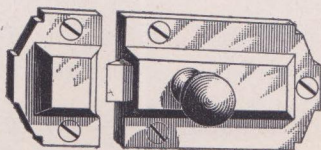

FIG. 85

110. **Elbow Catches.**—A convenient fastening that is in rather general use for the standing leaf of double doors, which is closed first and to which the other door is fastened, is illus-

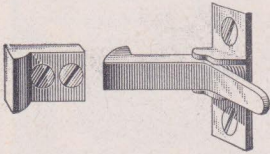

FIG. 86

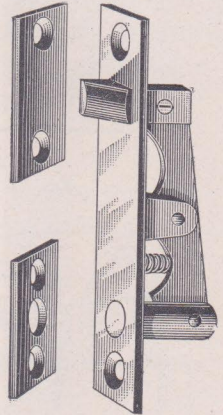

FIG. 87

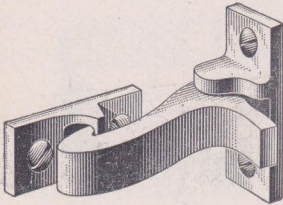

FIG. 88

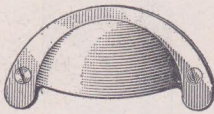

FIG. 89

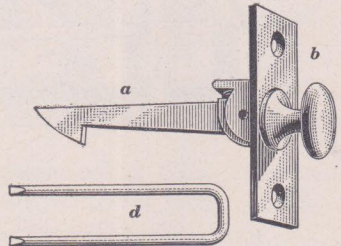

FIG. 90

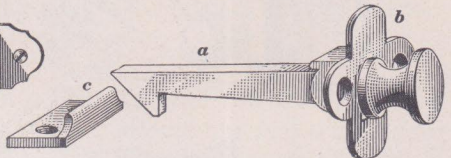
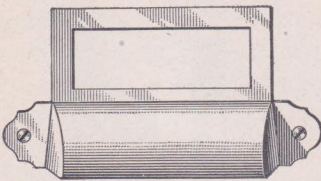

FIG. 88

trated in Fig. 86, from which the operation may readily be understood. This device, which is commonly known as an elbow catch, fastens the doors automatically; it is easily

operated in opening the doors. The strike of the catch should be placed beneath the shelf where possible, the catch being inverted.

111. Bookcase Bolt.—The bookcase bolt, shown in Fig. 87, is an automatic fastening device that is mortised into the soffit of cabinets or bookcases having double doors. It is arranged in such a position as to engage with the top of one door, and is operated by closing the other door, which carries the lock, so that both doors are fastened or released by a single action.

112. Lever Cupboard Catches.—Another piece of hardware used for securing light doors, or leaves, such as are used in cupboards, bookcases, and wardrobes, is illustrated in Fig. 88. This fastening is very simple and convenient. It consists of a bar *a* that is pivoted to a plate *b*, and extends through the door, its inner end being hooked to engage with a strike *c*, or a staple *d*.

113. Drawer Pulls.—The drawer pull is a familiar article of cupboard hardware, the usual type being illustrated in Fig. 89. This article can be obtained in iron, steel, brass, or bronze, in various styles and shapes, and in all finishes. Drawer pulls with label plates are extensively used. A type of this drawer pull is shown in Fig. 90.

114. Drop Drawer Pulls.—For cabinetwork, the drop drawer pulls as illustrated in Fig. 91 are used almost entirely. The drop pull is made both plain and ornamented, examples of each style being shown in (*a*), (*b*), (*c*), (*d*), (*e*), and (*f*).

115. Card Frames, or Label Plates.—An article known as the card frame, or label plate, is used extensively to placard drawers or cupboards to designate their contents. These plates are made in various sizes, and may be procured in bronze and iron, and in the usual patterns shown in Fig. 92.

116. Cabinet Locks.—The type of lock illustrated in Fig. 93 is used on cabinet work of every description, and can be procured for all classes of construction. These locks are made

in rim, flush, and mortise styles, with keys having either plain or ornamental bows.

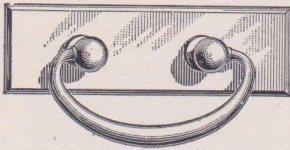

(a)



(d)

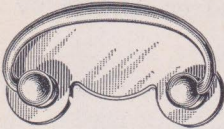

(b)



(e)



(c)

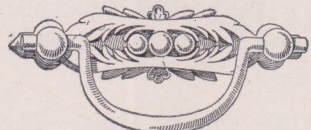

(f)

FIG. 91

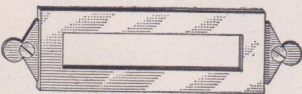

FIG. 92

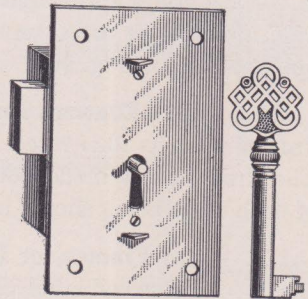

FIG. 93

117. **Cabinet Escutcheons.**—In order to form a finish and to protect the woodwork near the keyhole, the cabinet escutcheon plate is used. These plates are made in various sizes and styles of ornamentation, some designs of which are illustrated in Fig. 94.

118. **Hinge and Corner Plates.**—The hinge and corner plate is an article used solely for decorative purposes on cabinet-work. The variety of designs and sizes now available is such

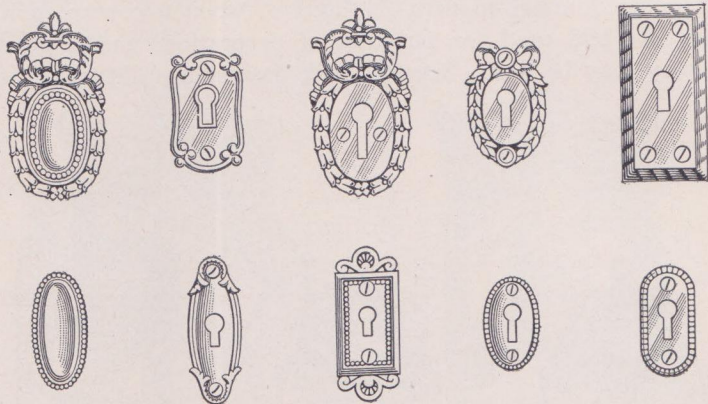

FIG. 94

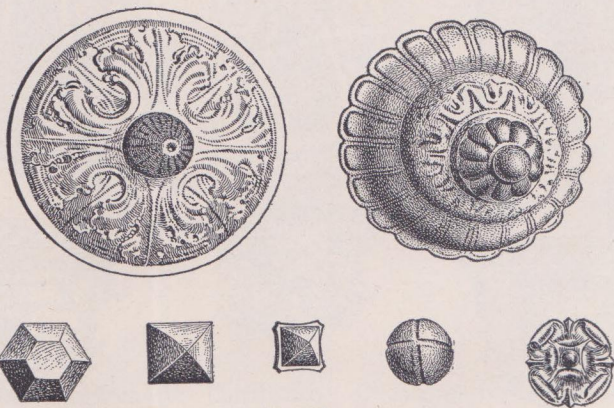

FIG. 95

that special patterns are rarely necessary. These plates may be obtained from the hardware dealer in the usual metals and finishes.

ORNAMENTAL HARDWARE

119. **Ornamental Nails and Studs.**—Although the constructive necessity for ornamental studs and nail heads has disappeared under modern methods of wooden construction, they are still used for purposes of decoration, and a great variety may be had. Several stock designs are illustrated in

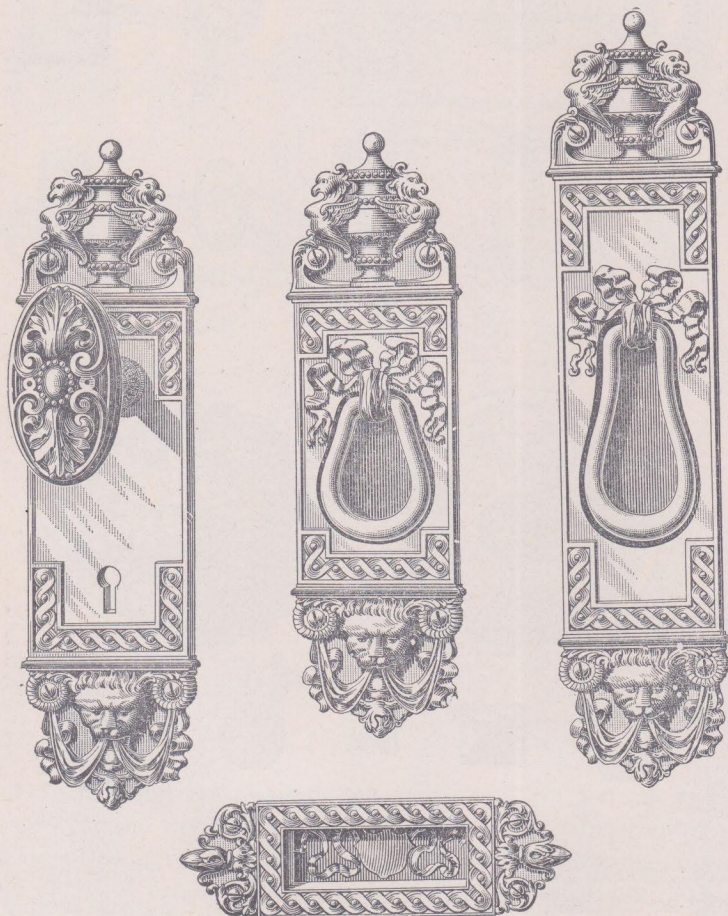

FIG. 96

Fig. 95. These nails and studs are made of various metals and in many finishes, having a projecting spur on the back that, when driven into the wood, firmly attaches the ornamental head in place. They contribute effectively to the decoration of important doors, especially exterior doors of churches and public buildings.

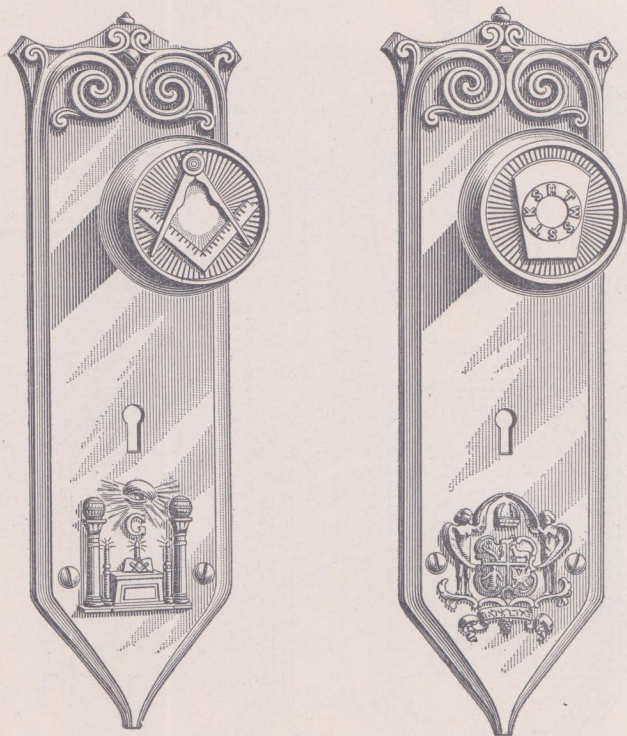

FIG. 97

120. **Emblematic Hardware.**—Occasionally, it is found desirable to indicate the character or use of a building by introducing one or more appropriate emblems in the design or ornament of the hardware. This is especially true of structures for lodges, clubs, societies, and other organizations, in which case the emblems of regalia, badges, etc. are available for the

motif of the design. In municipal, state, or government buildings, the coat of arms or public seal may be introduced in decorating the hardware, and in buildings for railroad companies, banks, etc., the monogram, seal, or name of the corporation is frequently reproduced.



FIG. 98

In all instances, the device selected is usually introduced as the central ornament of the door-knob. This ornament is also repeated on escutcheon and push plates, and generally on the larger pieces of metal work; and while it may constitute the sole feature of decoration, it usually has associated with it a border or other ornament.

The use of emblematic hardware involves the use of special designs and patterns, and thus generally entails a considerably greater cost than the use of standard patterns. In Fig. 96 are shown several standard ornamental designs, while in Fig. 97 are shown pieces of lock trim ornamented with heraldic, or emblematic, designs.

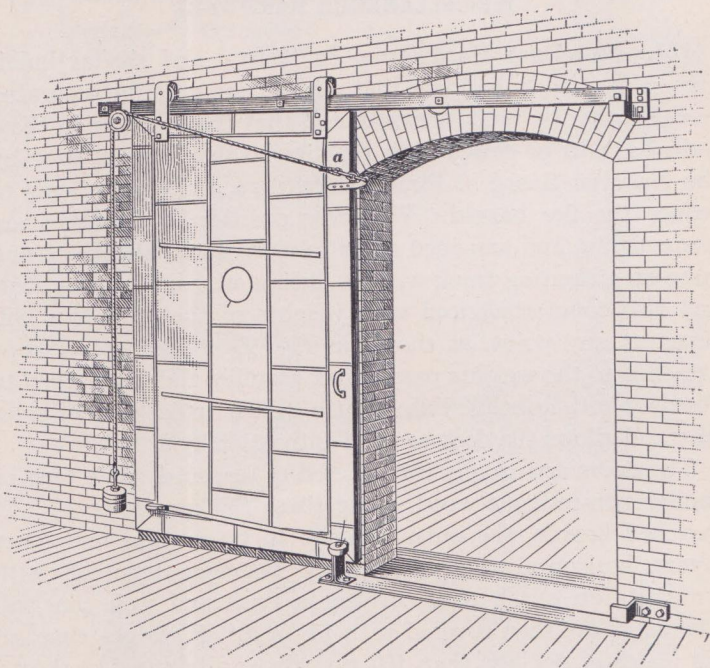

FIG. 99

121. Key Tags for Hotel Use.—In order to facilitate the return of hotel keys by the guests who may have taken their room key away with them, a tag such as illustrated in Fig. 98 is attached to the key by a metal link or chain. The key can be dropped into a letter box at any point and will be mailed to the hotel. The proprietor of the hotel will have to pay the cost of postage. The tags shown are artistic in effect as well as useful.

122. Hardware for Electric Fittings.—All the exposed hardware in rooms should be finished alike as far as possible. Electric fixtures, switch plates, etc., should be finished in the same metal and surface treatment as the hardware on doors, and windows.

MISCELLANEOUS HARDWARE

123. Fire-Door Hardware.—In factory and similar buildings, it frequently happens that one portion must be separated from another by brick firewalls, and that the openings in these walls have to be closed with tin-covered doors as required by the National Board of Fire Underwriters, the object being to reduce the fire hazard. Wherever possible, these doors are made sliding and arranged so as to close automatically, being hung on a slanting track with an incline of $\frac{3}{4}$ inch to the foot, and also counterbalanced with weights so that the door will stand at any point, as shown in Fig. 99. The cord or rope attached to the weights passes over a pulley and is attached to the door with a fusible link, as at *a*, which, in case of fire gives way and allows the door to close automatically.

The doors are usually constructed of seasoned white pine or similar non-resinous wood, using three thicknesses of $\frac{13}{16}$ -inch matched boards, the outside layers to be vertical and inner layers horizontal and thoroughly fastened together with wrought-iron clinch nails, driven in flush and well clinched. The doors are then covered with 14"×20" IC bright charcoal tin plates of not less than 107 pounds to a box of 112 sheets. All joints are locked $\frac{1}{2}$ inch, without soldering, and nailed under the seams.

The track for these doors is best made of round-edge bar iron or tire steel, $\frac{3}{8}$ in.× $3\frac{1}{2}$ in., being bolted to the wall with through bolts having nut and flanged washer on the opposite side, and held from the wall by cast-iron track brackets. The hangers are of wrought iron, $\frac{3}{8}$ in.× $3\frac{1}{2}$ in., provided with roller-bearing wheels and are attached to the door with at least two bolts. The binders are of wrought metal, $\frac{3}{8}$ in.× $3\frac{1}{2}$ in., with angle flange at back end to notch in the wall and so arranged

as to grip and force the door against the wall when closed. In connection with this, a wedge is placed at the end of the lower chafing strip, and, when the door is closed, engages with the stay roll so that the door will be held close to the wall on the opposite side. Two chafing strips of $\frac{3}{4}$ -inch, half-oval metal

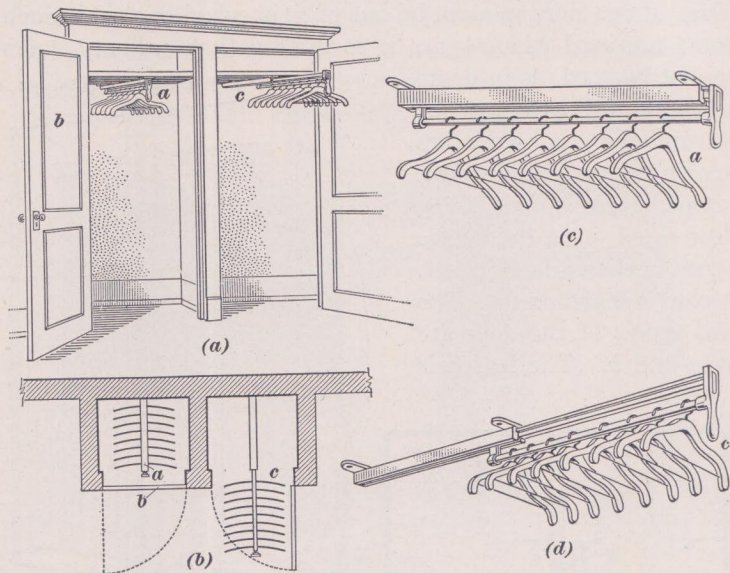

FIG. 100

are placed on back of door with $1'' \times \frac{1}{8}''$ flat strips of same length in front and bolted through the door. Bumper shoes are also used to prevent the binders from mutilating or damaging the tin covering at the points that strike the binders.

124. Miscellaneous Fittings.—In Fig. 100 is shown a type of closet fixture, designed for hanging a number of suits, coats, or dresses in a small closet. In (a) is shown a closet with the fixture *a* closed to permit the door *b* to close. At *c* is shown a fixture in an adjoining closet with the arm extended so that any desired piece of apparel may be removed. In (b) is shown a plan of the two closets showing the corresponding parts shown in (a). In (c) is shown a view of the fixture and hangers, as shown at *a* in (a). In (d) is shown a view of the fixture and

hangers extended, as at *c* in (a) and (b), all of the apparel being in the room, where it can be easily reached or removed. Hangers of this type are made in a variety of sizes or lengths, in order to make the maximum use of a closet of any depth.

Devices are made by means of which doors may slide, fold, or pivot to one side, so as to be out of sight when opened. Such doors are used where space is so limited that ordinary doors cannot be used, as in doors to telephone booths, lockers, wardrobes, etc., and are known as vanishing doors.

One type of vanishing door used in a telephone booth is shown in Fig. 101. A plan is shown in (a). The two leaves of the door are at *a* and *b*. The leaf *a* is

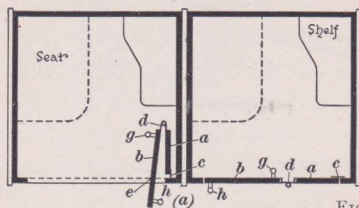
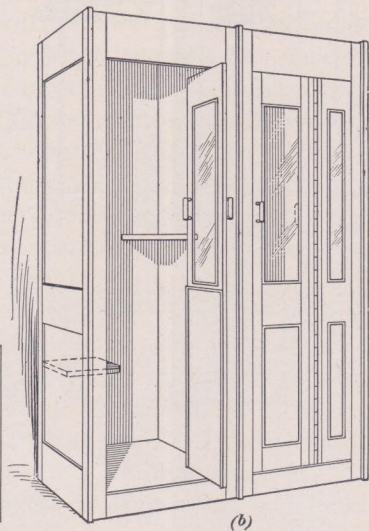

FIG. 101



hinged to the jamb at *c*. The leaf *b* is hinged to the leaf *a* at *d*, and is hung from a trolley in an overhead track at *e*. Handles are shown at *g* and *h*. At the right the door is shown closed. A perspective of the door in the two positions is shown in (b).

Another type of vanishing-door equipment is shown in Fig. 102. The doors *a* are hung on special extension hinges *b* at the top and bottom. These hinges are shown applied to wardrobe doors in a schoolroom, the fronts of the doors being fitted with blackboards *c* and chalkrails *d*. The doors swing into the wardrobes as shown, taking up very little space.

Many special devices other than the ones shown are supplied for use in new buildings or when remodeling old ones.

Directions for installing special devices are supplied by the manufacturers, and these directions must be followed carefully if satisfactory results are to be obtained.

GARAGE-DOOR HARDWARE

125. Types of Garage-Door Hardware.—Garage hardware consists essentially of devices for hanging, operating, and locking doors to garages. The door opening for the ordinary passenger car should not be less than 8 feet wide for a single

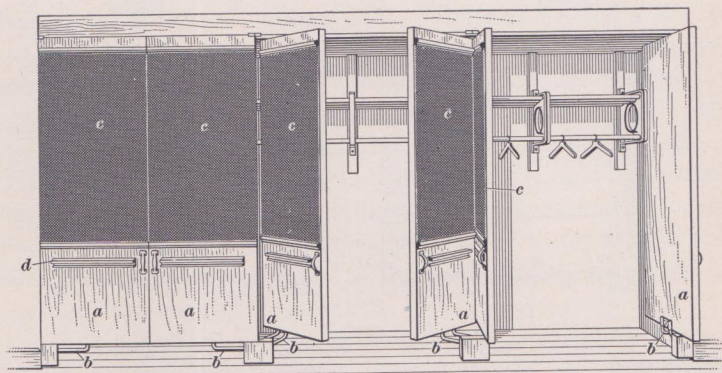

FIG. 102

car, or from 14 to 16 feet wide for a two-car garage. The height of the door should be about 8 feet, possibly a little less. In private garages the doors usually are operated by hand. In public or commercial garages the doors frequently are made to operate by electrically driven motors, controlled from any desired point.

In Fig. 103 are shown plans and sections of several types of garage doors. These doors may be classed as swinging, folding, sliding, and upward-acting, or overhead, doors. Combinations of these classes are also manufactured.

In (a) is shown a pair of swinging doors opening outward. The doors *a* and *b* are hinged to the jambs with three heavy T-hinges to each door. A hinged wicket door *c* swinging outward is built into the doors *a* and permits the entrance of a

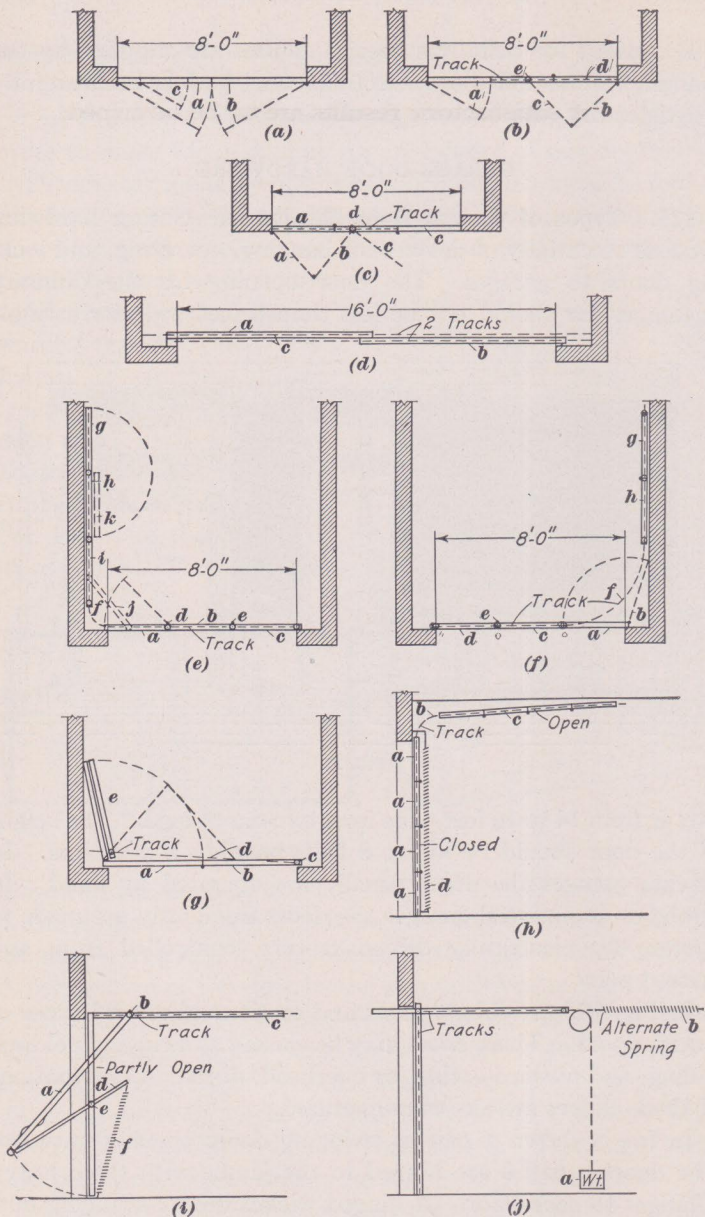

FIG. 103

person to the garage without opening the main doors. Doors of this type usually swing out so as not to take up room in the interior of the garage. The wicket door usually is provided with plain spring butts and a spring lock.

For a two-car garage a post is placed in the center of the opening, and a pair of doors, each pair 8 feet wide, is used on each side of the post.

In (b) is shown a triple-door opening, in which the doors *a* and *b* are hinged to the jambs with heavy T-hinges, and the door *c* is hinged to the door *b* and also supported in an overhead track *d* by the hangers at *e*. The doors *b* and *c* fold to one side, and the door *c* folds against the door *b*. The arrangement may be reversed, the door *c* being hung on the door *a*, and the doors *a* and *c* sliding to the left.

In (c) is shown an arrangement of three doors *a*, *b*, and *c*. The door *a* is hinged to the left-hand jamb, the door *b* is hinged to the door *a* and is also supported on a hanger at *d*. The door *c* is hinged to the door *b*, and the three doors fold and slide to the left-hand jamb. The doors may be arranged to open against the right-hand jamb.

In (d) a two-car garage is shown, with two sliding doors *a* and *b* suspended from overhead tracks *c* by hangers. Either door may be opened, giving space for a car to enter or leave. In this illustration the doors are shown on the inside of the front wall. They may be placed on the outside, in which case it will be necessary to place a cover over the track to protect the hangers and track from the weather. A wicket door may be placed in either door. Such a wicket door should be provided with spring hinges to keep it closed when not in use.

In (e) is shown a type of door in which three doors *a*, *b*, and *c* are hinged together at *d* and *e*, and the three doors slide as one unit around the corner on the overhead track *f* to the position shown at *g*, *h*, and *i*. One door is shown dotted at *j* making the turn from the front to the side of the garage. Sometimes one door, as *a*, is hinged to the door *b*, as indicated by the dotted lines, and may be opened separately from the doors *b* and *c*. When entirely opened, the door *a* then folds back against the door *b*, as shown by the dotted lines at *k*. This type requires

somewhat more space in the garage to permit the door *a* to open.

In (*f*) the door *a* is opened first to the position shown at *b*. The doors *c* and *d* are hinged together at *e* and slide on the overhead track *f* to the positions at *g* and *h*. This type of door may open to either the right, as shown, or to the left. The door *a* may open to one side and the sliding doors open to the other. This type of door requires additional space in the garage to allow the door *a* to open.

In (*g*) the door *a* is hinged to the jamb, and the door *b* is hinged to the door *a*, and is also supported by a hanger at *c*. In opening the doors, the hanger slides in the overhead track *d*, the doors folding against the wall as at *e*. The doors may open to either the right or the left. It will be seen from the plan that considerable space in the garage is taken up in operating the doors.

In (*h*) is shown an overhead door consisting of four horizontal strips *a*. In this door the sections follow a track *b* that extends up the sides of the door and is carried across the ceiling, so that in the open position the door is practically horizontal and close to the ceiling as at *c*. The door may be counterbalanced by springs at the jambs, as at *d* or in other positions. It may also be counterbalanced by weights at the side or rear of the garage.

In (*i*) is shown a vertical section of another upward-acting or overhead door. The door *a* is shown partly opened. The top of the door is supported by a hanger *b* which slides in an overhead track *c*. The lower edge of the door is fastened to bars or arms *d* which are pivoted at *e*. Springs *f* counterbalance the weight of the door while in an inclined position. When fully opened, the door is horizontal along the line of the track *c*. The doors may be counterbalanced by weights, or by springs in various positions other than shown.

In (*j*) is shown a type of door in which a weight or spring *b* is used to counterbalance the weight of the door. Tracks extend up on the two sides of the door, and a single track may carry the top of the door back to the open position. Sometimes the lower end of the door is designed to extend outside the wall when the door is in the open position, forming a canopy, as shown.

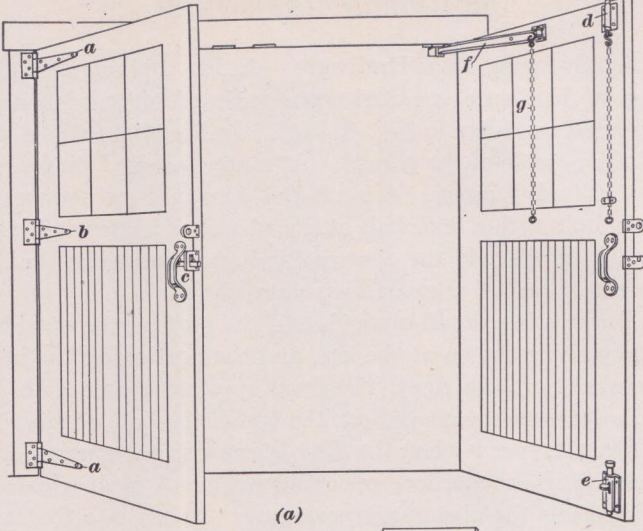

(a)

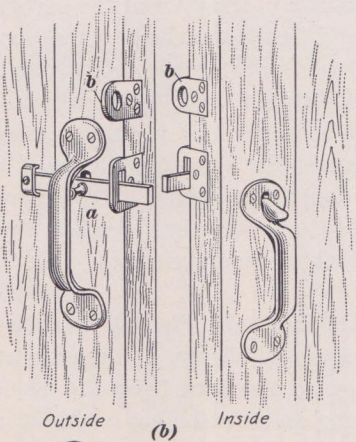

(b)

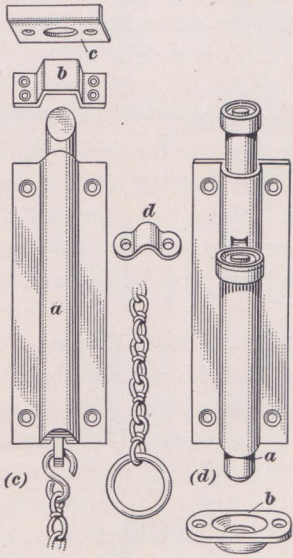

(c)

(d)

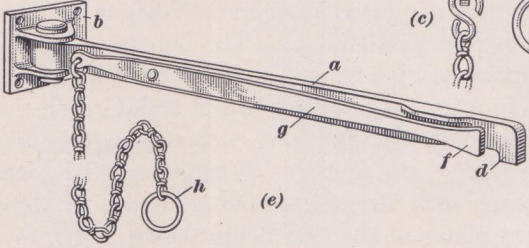

(e)

126. Swinging-Door Hardware.—In Fig. 104 are shown the pieces of hardware required for a pair of outward-swinging doors such as shown in Fig. 103 (*a*). In Fig. 104 (*a*) is a view from the outside of the garage. At *a* are 16-inch **T** hinges, and at *b* a 10-inch **T** hinge. A latch and door pull are shown at *c*, a chain bolt at *d*, a floor bolt at *e*, and a door holder at *f*. The door holder will hold the door rigidly in position while the door is open and can be released by pulling the chain *g*.

In (*b*) at *a* is a detail of the latch, the part on the outside of the door being shown at the left, and the portion on the inside being shown at the right. Padlock eyes are shown at *b*. In (*c*) is a detail of the chain bolt, the top of the bolt *a* being held by a strap keeper *b* when the door opens into the garage, or by a socket *c* when the door opens outward. A strap cleat *d* is used to keep the chain from swinging. In (*d*) is a foot bolt, the lower end *a* fitting into a socket *b* in the floor of the garage.

In (*e*) is a door holder, one end being attached to the door as at *f* in (*a*). The bar *a* in (*e*) turns on the pivot *b*, which is attached to the door, and slides through the block *c*, which is attached to the head jamb. When the door is fully opened the end *d* of the bar *a* is held against the lug *e* and the end *f* of the locking bar *g* prevents the door from closing. By pulling down on the chain *h* the end *f* of the locking bar is raised, and the bar will slide through the block as the door closes.

127. Hinged Folding-Door Devices.—In Fig. 105 is shown a pair of doors supported by hinges and also by a hanger in an overhead track. In (*a*) is a view of the door from the inside of the garage. The door *a* is hung on offset hinges *b*, shown in detail in (*b*). The door *c* in (*a*) is hung on the edge of the door *a* by hinges *d*, shown in detail in (*c*). The outer end of the door *c* in (*a*) is supported by a hanger *e*, shown in detail in (*d*). The hanger slides in a track *f* in (*a*), shown in detail in (*e*), the track being supported by hangers *g*, *h*, *i*, and *j* in (*a*), and shown in detail in (*f*), (*g*), (*h*), and (*i*). When closed the doors are locked by means of a Cremorne bolt *k* in (*a*), the top, center, and bottom plates of the bolt being shown in (*j*), (*k*), and (*l*). This bolt may be fitted with a key so that the door

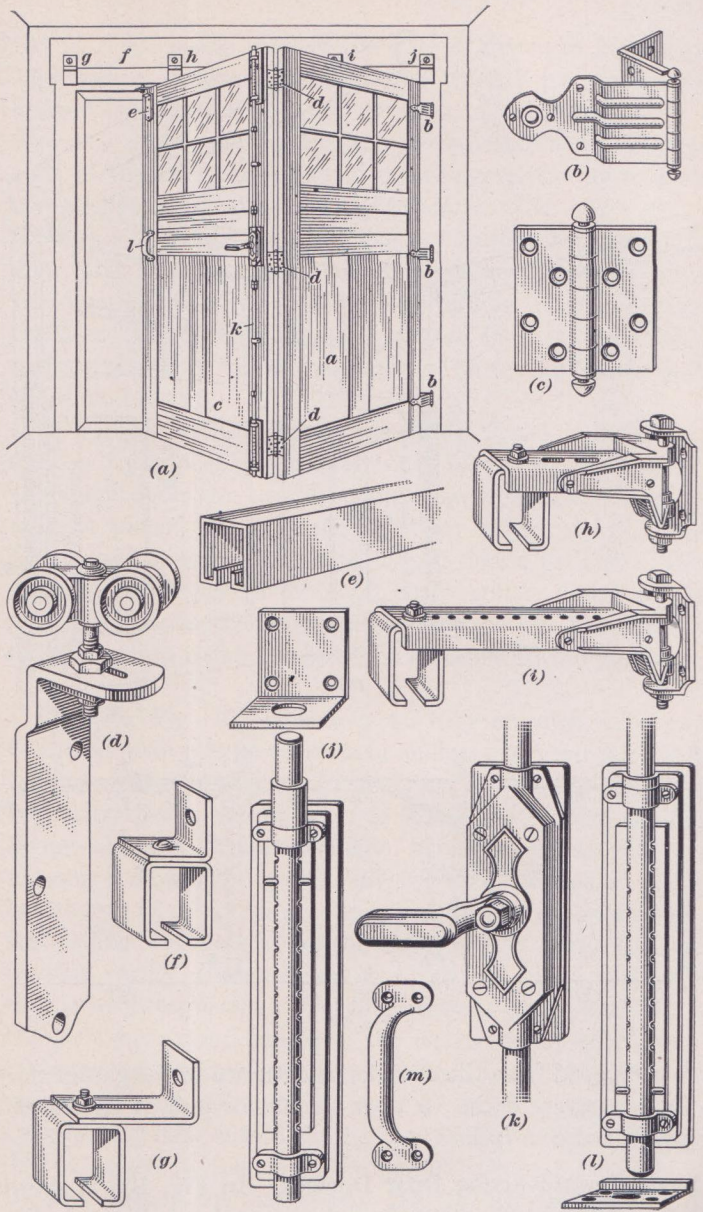

FIG. 105

103 (*i*). An inside view of the door is shown in Fig. 106 (*a*). The door *a* is suspended from the track *b* by means of the hangers *c*. Operating bars, or arms, *d* are attached to the door at *e*, and to pivots attached to the jambs at *f*. The upper ends of the bars are attached to springs *g*, the lower ends of the springs being attached to the jambs at *h*. At *i* and *j* on the inside and outside of the door are handles for operating the door, and at *k* is a pull chain for lowering the door when in the open position. By pushing or pulling out the bottom of the door the top of the door is pushed back in the track, the springs acting as counterbalances. The tension of the springs is adjustable at *h*.

In (*b*), (*c*), and (*d*), the door is shown closed, half-raised, and entirely raised. The same reference letters are used as in (*a*).

Garage doors are usually supplied with locks. These locks may be placed on or in the stiles for hinged doors. Sliding doors used in connection with hinged doors, as in Fig. 103 (*c*) and (*f*), usually have foot and chain bolts. Overhead doors may have locks placed at either side of the door, the bolt extending into either the jamb or a keeper on the jamb.

129. In Fig. 107 is shown an interior view of a garage equipped with a type of vertical sliding overhead door similar to that shown in Fig. 103 (*h*). Doors of this type are known by various trade names, such as Roll-Up, Rol-Top, Overhead, Swing-Up, the hardware made by different manufacturers varying somewhat. In Fig. 107 (*a*) four sections of the door are shown at *a*. At *b* are tracks along the jambs and across the ceiling. Rollers *c* on the door roll in these tracks. A tension spring *d* counterbalances the weight of the door so that it operates easily. The four sections of the door are held together with strap hinges *e*, the edges of the sections being rabbeted to make a weather-resisting joint. Handles *f* are placed on both sides of the door in order to operate it. A cylinder rim lock with a sliding bolt is shown at *g*. When the door is raised by means of the handles *f* a drop, or pull, cord permits pulling the door down. In (*b*), (*c*), and (*d*) the door is shown closed, partly open, and entirely open.

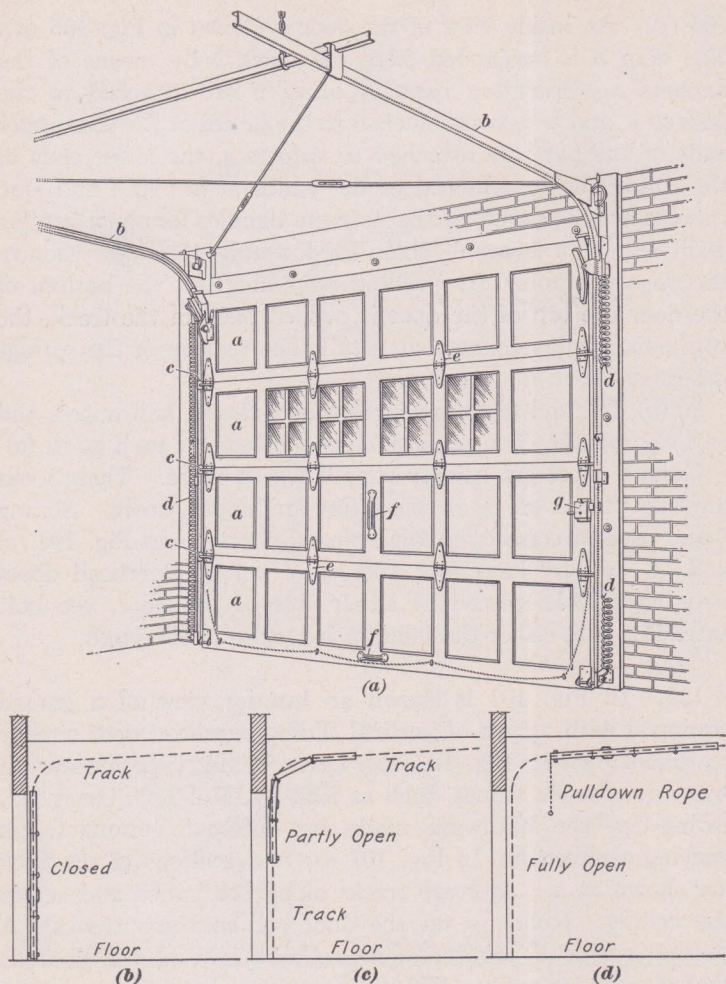

FIG. 107

The overhead type of garage-door hardware takes up practically none of the usable space of the garage, and may be installed in a garage where there is about 1 foot of space above the top of the door opening.

With any type of garage hardware selected, the manufacturer includes directions for installing the devices.

SELECTION AND SPECIFICATION OF HARDWARE FOR BUILDINGS

130. Selecting Hardware.—The manufacturers of hardware have assembled an extensive collection of standard designs in the various styles of ornament, from which fitting selections can be made for almost every use without danger of repetition and without fear that the design selected may become hackneyed by too general use. Therefore, before incurring the great expense entailed by the adoption of special designs, it is advisable that a careful examination of catalog designs be made. Where, however, it is decided to adopt some special design, the facilities of the manufacturer can be effectively utilized to secure the best results at the least cost and with the minimum amount of trouble to the architect or the owner.

131. Customary Method of Selecting Hardware.—A satisfactory plan for selecting hardware is to exclude the finishing hardware from the specifications prepared for the building and to reserve it for selection by the architect and the owner. In that case a lump sum is named in the specifications. The owner and the architect select the hardware directly from samples. If this selection costs more than the allowed sum, the excess is paid by the owner, and vice versa.

132. Method of Listing From Catalogs.—In some cases the architect makes an exact list of the finishing hardware in which every door, window, cupboard, drawer, etc., is accurately listed. The architect will select from the catalog of standard hardware manufacturers the items of hardware that will meet his requirements for usefulness and design. This list is included in the specifications of the work to be done and estimates are obtained from the contractors in the usual manner. In the specifications, the contractor may have the option of submit-

ting with his bid on the goods specified, an alternate bid based upon goods of equal quality that are made by any satisfactory manufacturer.

Examples of the items as they may be specified follow:

- 1 *Entrance door, 3'4"×7'0"×2¼"*
 - 1½ pr. BB180F -- 5"×5" Butts
 - 1 #0E3861 GA lock set 6 pass
 - 1 Panel button # OE 9184 GA
 - 1 Letter box plate # OE 259 GA
 - Transom—1 pr. Butts #291F, 3"×3"
 - 1 Transom lift #263—4 ft.
- 2 *Double-acting doors*
 - 2 Premier floor hinges
 - 2 Push plates OE 892 SW 14½×¾"
 - 2 Push plates N 892 SW 14½×¾"
- 12 *Double-hung windows*
 - 10 Sash fasts # OB 258
 - 22 Sash lifts # OB 1887 SW
 - 2 Fasts # N 258
 - etc.

The various letters, numbers, etc., are similar to those shown in the catalogs of prominent hardware manufacturers and indicate definite articles that are made by the manufacturers.

Such a specification gives positive descriptions of the hardware required. Any changes made by the architect or the owner, or any alternate bids made by the contractor may be considered or made as desired, and corresponding adjustments made in the costs.

133. Sample Specifications for Small Work.—A sample specification for a small or moderate-sized building follows:

SEE GENERAL CONDITIONS

NOTE.—Under the head of *General Conditions* preceding all specifications furnished to contractors by the architect, a series of binding requirements, reservations, and stipulations are specifically stated, and it is most essential that the contractor carefully peruse them, as he is bound by them as well as by the clauses under the heading of the specifications for Building.

Rough Hardware.—Provide all the rough hardware, such as nails, screws, sash weights, pulleys, chain or cord, anchors, screw bolts, and all other material in this line necessary for the completion of the operation.

Finishing, or Builders', Hardware.—The contractor shall include in his estimate the sum of _____ dollars (\$ _____) for the purchase of

the finishing hardware, which is to be selected by the architect or owner and charged to the contractor. If the hardware costs less than the stipulated amount, the difference shall be deducted from his contract price; if it costs more than herein contemplated, the owner will pay to the contractor the additional amount.

The above hardware is to include all fastenings and metal trimmings used on doors, windows, transoms, closets, cabinets, pantries, etc., and will be delivered at the building in the quantities and at the times reasonably required by the contractor, he to apply the same under the direction and to the satisfaction of the architect.

The contractor is to be responsible for all hardware after delivery and until the completion of the building. He shall hang all doors, properly fit all locks, etc., and return them to their original packages until after completion of the painting or finishing, when he shall place them permanently. All knobs shall be covered with Canton flannel, to protect them from injury, and all keys are to be cared for until the building is delivered to the owner. The contractor shall place all keys in their locks or deliver them to the architect with tags attached, indicating where they belong.

The contractor shall furnish the manufacturer or dealer furnishing the hardware with details of woodwork or information that may be necessary in order to understand the requirements and to harmonize the hardware with the cabinetwork, and, where interferences are discovered, to have them adjusted before the hardware is delivered.

SCHEDULES OF THE HARDWARE

134. Hardware Schedules.—The contractor for the hardware usually takes off his own bill of material from the general drawings and the specifications furnished by the architect. However, the architect will sometimes supply the hardware schedule and obtain prices for the same direct from the dealer, thus saving the owner the general contractor's profit and insuring bids based on material of uniform character and quality. It is well, therefore, to give some thought to the preparation of the schedule, so as to insure a good classification and to avoid omissions.

In drafting a schedule of hardware required for a building, it must be compiled from a copy of the hardware specifications and a list of all openings, cabinets, etc. that has been taken from the drawings. The schedule should be sub-divided primarily into building sections, such as *first floor*, *second floor*, etc. as headings. Under these headings, each opening or group of

openings in each room or division should be listed. Under the name of each opening or series of openings should be grouped all the hardware required. Each and every article necessary should be itemized and the quantity, numbers, sizes, or dimensions, design, and finish should be stated.

Schedules thus prepared are readily priced for estimating, and such classification eliminates the possibilities of omissions. Besides, the order can be executed by the manufacturer in exact conformity with the instructions, the hardware for each opening can be combined in a separate package, and each package clearly labeled to indicate its contents and the room or opening to which it belongs. The following shows a typical form of schedule:

First Floor

One Pair of Entrance Doors, 2'8"×7'6"×2¼" Rt.-Hd. rabbeted.

- | | |
|--|---------------------|
| 1 cylinder, front door, Set No._____. | Plain bronze metal. |
| 1 push button, No._____. | Plain bronze metal. |
| 2 extension flush bolts, No._____, 1-12", 1-18". | Plain bronze metal. |
| 3 pair of butts, No._____, 5"×5". | Plain bronze metal. |

One Pair of Sliding Doors, Hall to Parlor, 2" astragal face, 1½" friction strip.

- | | |
|---|---------------------|
| 1 set of locks, No._____, 3" backset. | Plain bronze metal. |
| 3 dozen countersunk screws and washers. | Plain bronze metal. |
| 2 sets of antifriction, noiseless, parlor-door hangers and track, complete, No._____. | |

Pantry Cupboard.

- | | |
|--|----------------------|
| 2 pair of doors, 1½"; 2 single doors, 1½". | |
| 1 tilt flour bin; 4 drawers (2 narrow). | |
| 6 pair of butts, No._____, 2½"×2½". | Plain bronze plated. |
| 1 pair of butts, No._____, 3"×2½". | Plain bronze plated. |
| 2 elbow catches, No._____. | Japanned. |
| 4 cupboard turns, No._____. | Plain bronze plated. |
| 7 draw pulls, No._____. | Plain bronze plated. |

Second Floor

Ten Doors, 2'8"×7'0"×1¾", 6 R. H., 4 L. H. transom, top-hung.

- | | |
|---------------------------------------|----------------------|
| 10 inside lock sets, No._____. | Plain bronze metal. |
| 15 pair of butts, No._____, 4½"×4½". | Plain bronze plated. |
| 10 pair of butts, No._____, 3"×2½". | Plain bronze plated. |
| 10 transom lifts, No._____, 5/16"×4'. | Plain bronze plated. |
| 10 wooden-base knobs, 2½" diameter. | |

DOUBLE-HUNG WINDOWS

10 sash fasts, No._____.	Plain bronze metal.
20 sash lifts, No._____.	Plain bronze metal.
10 sash sockets, No._____.	Plain bronze metal.
4 sash hooks, No._____.	Plain bronze metal.
10 dozen adjusting screws and washers.	Plain bronze metal.

The foregoing schedule is merely intended as an example of a classified, brief, and at the same time comprehensive hardware schedule. A schedule of this kind shows, almost at a glance, the nature of the hardware to be supplied, and if prepared by the architect, should tend to procure bids based on uniform requirements.

135. Detail Drawings for the Hardware Contractor.—In some architects' offices, it is the practice to provide, on a single detail sheet, cross-sections of every type of door stile in the building. The time required to make such a drawing is slight, while the results accomplished are most useful. Copies of this drawing are furnished to the contractors for the cabinet trim and to the hardware contractor, so that each of them will have identical information and that the work will assemble properly when the hardware is put in place.

Such drawings should show the dimensions of the transverse sections of the vertical stile, or lock stile for each door, also the overlapping, if any, of panel moldings, together with the shape of bevels, rabbets, astragals, and any other details affecting the size and location of locks, hinges, butts, etc. The hand of the doors is usually, and better, indicated on the floor plans. A further argument is that the character and dimensions are liable to be overlooked when arranging the paneling of doors; whereas, both should be considered. The use of narrow stiles, special rabbets, and astragals, shelf effects, friction strips, etc. is resorted to without sufficiently considering the disadvantages that result from the contracted space in which the lock and its trim must be placed. Where the items just mentioned are proposed, the architect should ascertain what locks are available and should provide space for those selected. Special locks are always expensive, while a cramped space precludes the best construction.

136. Taking Off Hardware From Plans.—The schedule of finishing hardware for a building must be made from the architect's plans and specifications. Therefore, where possible, this work should be done by a hardware expert or salesman, or by some person who has the ability to read drawings easily and accurately and who is capable of exercising thoroughness in every detail of the work. A salesman would list each item as illustrated in the article on Method of Listing From Catalogs.

The list of hardware should be compiled in a systematic manner, beginning at a definite point in the building and progressing through the several rooms and floors in a definite order. This will insure the inclusion of every part of the building and the careful consideration of every opening or other place where hardware is required. For example, in the case of a residence, it is customary to commence with the items at the front entrance, including the front and vestibule doors, to pass thence to the hall and to take each room on the first floor in due order, then to the second floor and to each room on it in like order, and so on until each floor is covered. The attic and basement are usually left until last, because they require a simpler class of goods. The same general system can be followed in the case of hotels, office buildings, apartment houses, and other buildings, the essential point being that an orderly method be followed. The rooms should always be taken in natural sequence, and all openings of similar character totaled and again counted on the drawings, so that the chances of omission are minimized.

137. In the case of doors, it is necessary to make note of the size and thickness, the hand, and the bevel, or rabbet, as required. In all cases three butts should be used on exterior doors, and also three butts on interior doors 7 feet or more high. The size of the butts should in all instances be sufficient to cause the door to clear the trim. The width of stiles and the general construction of the doors should be noted, particularly the front-entrance doors, as architects sometimes design these regardless of the hardware that is to be used on them. Frequently, a careful scaling and scrutinizing of elaborately

designed doors will show a shelf effect returning back to the lock stile, covering nearly half its width, just about where the lock should be placed. Such defects can be remedied easily, if observed in time, by directing the architect's attention to them.

In the case of sliding doors, it should be noted whether they are single or double, what is to be the character of the hanger, or rail, and the length of the run, and whether the door has a flat or a half-round astragal. The width of the stile and the size of the friction strip should also be noted, so that the hardware will not conflict with the woodwork, moldings, etc., as, where necessary, special backsets can be procured on sliding-door locks to overcome this trouble.

Where double-acting doors are shown, note should always be taken of the thickness, width, and height, also of the width of the lock stile and the height of the bottom rail, so that, if push plates or kick plates are required, the suitable dimensions for them can readily be estimated. The dead locks for these doors should be ordered with oval fronts for single doors and oval fronts and strikes for double doors, to allow for neat fitting to the rounded edge of the doors. Where kick plates are required for double doors of this character, flush bolts should be mortised into the edge of the door, so that the lower bolt will not interfere with the kick plates.

138. In stating the information for windows, full details are needed as to whether they are single- or double-hung, French casement, stationary, or ordinary casement. Double-hung windows 20 inches or less in width require only one sash lift. Extra-wide windows, such as those over 36 inches, should have either bar lifts or two extra-heavy hook sash lifts. The window stops should be studied in detail, so as to estimate the number of screws that will be required for each window. In the case of French windows, it is well to determine the height, the width of the stile, whether the joints are rabbeted, beveled, or flat, the hand, and whether the windows swing in or out; detail cross-sections through head-jambs, casing, and lock stiles should also be procured if possible. In casement sash, the

pivoting should be noted, so as to determine whether it is vertical or horizontal; the swing should also be observed, and if the sash are to be hinged, determine whether the hinges should be placed at the top, the bottom, or the sides. As in the consideration of doors, the thicknesses and sizes of all casements should always be noted. Sections through the jambs, trim, and stiles should be taken at the points where the hardware is to be applied.

139. In order to determine the kind and length of the lifters to be used on the transoms, it is necessary to note the distance from the floor to the center of each transom, also whether they are to be pivoted or hinged from the bottom or the top, and how they are to swing. The cross-section through side jambs and casings should always be ascertained, in order to see that the hardware will be suitable to meet the conditions of the trim.

140. It is necessary to learn all details of the pantry, including the thickness and height of doors, whether they are double or single, and the number of each kind. Note all drawers; those under 20 inches in width require only one pull. The details of the flour bins should be examined to determine whether they are to be hinged at the bottom and are to tilt, or whether they are to be curved on plan and are to be hinged at the side, as each condition requires different hardware.

141. Where unavoidable interferences are discovered, or where the plans and specifications are obscure or defective, a note of the facts should be made, and when all such matters have been collected, they should be submitted to the architect for his decision as a basis for final determination.

142. Allowance for Finishing Hardware.—Architects are constantly called on to prepare preliminary estimates on proposed buildings, to assist clients to determine whether they can afford to build. For this purpose, the architect possesses an approximate knowledge of the cost of excavation, masonry, woodwork, etc., so that the necessary expenditure may be computed with a fair degree of accuracy. Builders' hardware,

however, does not readily admit of accurate preliminary estimating, and in many cases the architect merely specifies the sum to be expended for finishing hardware, stating that selections are to be made by himself or his client later, as the work progresses. This system is found in many instances to be satisfactory to all—architect, client, and builder.

The cost of the hardware usually bears a fairly constant ratio to the total cost of various types of buildings. The following figures, which are based on experience, indicate the range in this ratio under ordinary conditions. This schedule gives the ratio of cost of finishing hardware to the total cost of the building, land excluded.

<i>Type of Building</i>	<i>Per Cent</i>
Hotels, large.....	1.00 to 1.5
Hotels, small.....	1.50 to 2.0
Apartment houses.....	1.50 to 2.0
Office buildings.....	1.00 to 2.0
Office buildings, fireproof.....	.50 to 1.5
Public buildings.....	1.50 to 2.0
Libraries.....	.75 to 1.5
Hospitals.....	.50 to 1.0
Residences, city.....	1.50 to 3.0
Residences, country.....	2.00 to 4.0

APPLICATION OF HARDWARE

143. Owing to the fact that hardware has become more intricate in its manufacture and therefore more complicated in its construction, it is found that the proper amount of intelligence is not always exercised in its application. Frequently it is applied so carelessly that the hardware practically loses its most essential features. In the case of mortise-lock sets, all of the better grades are made with easy springs, so that the door will close gently and surely. However, this one feature alone is sometimes obliterated by careless application. The trouble in this direction is principally caused by the carpenter fitting the lock into the door untrue, and then screwing the escutcheons to the doors out of plumb and alinement. This causes the knob shanks, when rotated, to bind, or stick, in the

sleeve, or collar, of the escutcheon, thereby holding back the latch bolt after the latch is withdrawn into the lock case. It is also found that proper adjustment is seldom given to the knobs and spindles passing through the escutcheons. In many cases when the hardware is applied carelessly, the owner, not knowing the real cause of the trouble, condemns the best hardware as being cheap and unsatisfactory.

In the application of cylinder locks for either front doors or office doors, it is found that the average mechanic is apt to make mistakes. In some cases, the locks are inverted, with the cylinder below the knobs, when it is designed to be above; also, sometimes, in reversing a front-door lock having a night latch, good judgment is not always used.

144. Such troubles as those just described can be easily overcome, and if the methods of applying hardware that follow are strictly adhered to, satisfactory operation will be assured.

Reversing the ordinary mortise, or rim, lock requires no special ability on the part of the workman, as the operation consists of merely taking off the cap and turning over the latch bolt. Where, however, a mortise lock is to be applied, care must be exercised so that it will work properly. First fit the lock into the door at the proper height from the floor, making the mortise large enough for the lock to enter easily. Bore the holes for the knob and the key, and insert the screws in the lock face and drive them home. Now take the escutcheons, or roses, and knobs and apply them to the door, carefully adjusting the knobs and spindles so that there is only slight play in the length. Then true up both escutcheons, by holding one with the thumb and the other with the fingers. When this much is accomplished, turn the knobs right and left to see whether they work properly; if they bind in the collar, adjust the escutcheons a trifle, vertically or horizontally, until the knobs rotate back to the original position in both directions without binding. By using a scratch awl and punch carefully, the exact center of each screw hole may be located, and by holding the awl perfectly true the screws will be started true. The escutcheons may now be released and the screws driven

home. If this method is carefully followed, workmen will find that the latch bolt will work properly in almost every case. Always try the knob, when the application is completed, by rotating both to the right and to the left, and if found to bind, always make the proper adjustment before leaving the work.

145. In fitting strikes to the jambs, it is suggested that the workman locate them as low as possible, to conform to the locks, leaving the margin in the strike below the lock bolts. Doors in new buildings are liable to sag slightly, and if proper allowance is not made, the strikes may have to be readjusted, sometimes even before the contract is completed.

It is also necessary for the carpenter or superintendent to caution the painters not to paint or varnish any hardware, especially the lock faces, as this will also retard the operation of the latch bolt. As previously stated, the hardware should be fitted to the work and then replaced in the original packages, so as to protect it from abuse and damage, it being applied permanently only after the painting is completed.

146. In applying cylinder, or front-door, locks, the conditions are still more difficult to overcome. When reversing cylinder locks that have swivel spindles, unscrew the cap and reverse the latch bolt; also, reverse the hubs, that is, the parts of the lock through which the spindles pass. Cylinder locks should always be mortised into the door at the proper height from the floor, and the holes for the cylinders and knob spindles then made. Insert the lock into the mortise, but do not put screws into the face; then apply the escutcheons and adjust the knob, taking care that the swivel of the spindle centers at the joint in the split hub. Now proceed to screw in the cylinder to its full extent, so that the cylinder collar is held rigidly between the cylinder and the escutcheon, and the cylinder is perfectly vertical. Then set the cylinder adjusting screw, and insert the wooden screws in the lock face and drive them home with the screwdriver. Hold and adjust the escutcheon so that the knob will rotate back and forth automatically without friction, starting the screw holes with an awl. If the doors are made of hardwood, an automatic drill will have to be used

to bore the screw holes. In such a case, follow the directions just given regarding escutcheons; then start the holes with a scratch awl while still holding the escutcheons, and enlarge the holes with the drill. Screws that are off center, when driven home into the countersinking, will surely draw the escutcheon so that the knobs will bind and thus destroy the most desirable feature of the lock.





